

Service Bulletin

Subject:

Flight Control Needle Roller Bearings

Applicability:

This Service Bulletin is only applicable to the Elevator and Rudder Hinge part numbers listed in Table 1.

Table 1 – Part Number Applicability

AIRCRAFT	PART NUMBERS
GA8/GA8-TC 320	GA8-551021-191, Inboard Hinge GA8-551021-192, Inboard Hinge (RHS) GA8-551021-193, Centre Hinge GA8-551021-195, Outboard Hinge GA8-551021-196, Outboard Hinge (RHS) GA8-553021-301, Rudder Hinge No. 1 GA8-553021-303, Rudder Hinge No. 2 GA8-553021-305, Rudder Hinge No. 3

These Hinges are fitted to aircraft identified in Table 2.

Table 2 – Applicability

AIRCRAFT	SERIAL NUMBER(s)
GA8	GA8 aircraft modified in accordance with SB-GA8-2006-36 GA8 aircraft modified in accordance with SB-GA8-2011-73 GA8-06-115 and subsequent
GA8-TC 320	GA8-TC 320 aircraft modified in accordance with SB-GA8-2011-73 GA8-TC 320-09-151 and subsequent

Amendments:

Issue 1: Initial Issue

Background:

This Service Bulletin provides instructions for replacing the Rudder and Elevator Hinge interference fit and sliding fit bushes with sealed needle roller bearings.

Compliance:

The accomplishment instructions contained within this Service Bulletin are optional and may be incorporated at the Operator's, Owner's or Maintenance Provider's discretion.

Weight and Balance:

The effect of this Service Bulletin's incorporation on the aircraft's weight and balance is negligible.

Electrical Load Analysis:

There is no effect on the aircraft's electrical load analysis from this Service Bulletin.

Approval:

The airframe modification described in this Service Bulletin has been approved pursuant to Australian Civil Aviation Safety Regulation 21.095 (1998). GippsAero Reference GAE11#2167.

Parts:

The following parts are required to accomplish this Service Bulletin.

Table 3 - Parts

ITEM	PART No.	DESCRIPTION	QTY	REMARKS
1	MS24462-4	Needle Roller Bearing	LHS of Horizontal Stabiliser – 3 RHS of Horizontal Stabiliser – 3 Rudder - 3	RBC Aerospace Bearings P/N 4NCC910P
2	NAS1149F0416P	Washer, Plain	As required	
3	NAS1149F0432P	Washer, Plain	As required	
4	NAS1149F0463P	Washer, Plain	As required	
5	-	4130N Steel Bar per MIL-S-6758 or AMS-S-6758	5/8" diameter minimum Length as required	See Part B and Part C

Parts Availability:

New parts can be obtained directly from GippsAero.

Tel: +61 (0)3 5172 1200

Fax: +61 (0)3 5172 1201

Email: aircraft.support@mahindraaerospace.com

Labour:

The time required to accomplish this Service Bulletin will vary depending upon which Hinges are modified and the methods used to fabricate parts locally should they be required.

Warranty:

No aircraft are eligible for warranty claims incorporating this Optional Service Bulletin.

Identification of Parts

The Rudder and Elevator Hinges identified by this Service Bulletin are machined parts that attach to the Rear Spar of the Vertical Stabiliser and Horizontal Stabiliser respectively.

The Hinge lugs are factory fitted with an interference fit bush, and when the flight control is fitted a sliding bush is installed inside the interference fit bush. The flight control is then attached with regular airframe bolts.

Figure 1 – Typical Hinge part identification

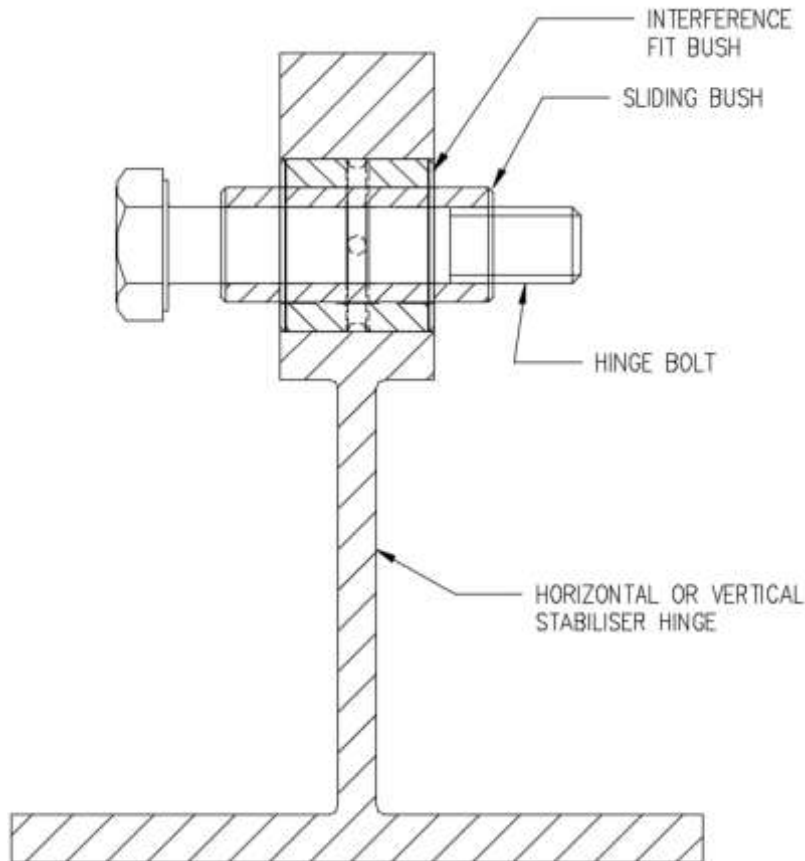

Table 4 – Hinge and associated part numbers

Flight Control	Hinge	Interference Fit Bush	Sliding Bush
LHS and RHS Elevator	GA8-551021-191 (LHS) GA8-551021-192 (RHS) Inboard Hinge Bracket	GA8-552021-167, Bush	GA8-552021-063, Inboard Bush
	GA8-551021-193, Centre Hinge Bracket	GA8-552021-167, Bush	GA8-552021-067, Centre Bush
	GA8-551021-195 (LHS) GA8-551021-196 (RHS) Outboard Hinge Bracket	GA8-552021-165, Outboard Bush	GA8-552021-065, Outboard Bush
Rudder	GA8-553021-301, Rudder Hinge No. 1 (Lower Hinge)	GA8-553021-275, Top Hat Bush	GA8-554021-025, Rudder Bush
	GA8-553021-303, Rudder Hinge No. 2 (Centre Hinge)	GA8-553021-279, Rudder Hinge Bush	GA8-554021-025, Rudder Bush

	GA8-553021-305, Rudder Hinge No. 3 (Upper Hinge)	GA8-553021-279, Rudder Hinge Bush	GA8-554021-025, Rudder Bush
--	--	--------------------------------------	--------------------------------

Accomplishment Instructions:

The following instructions are applicable to the Left Hand Side (LHS) of the aircraft; the Right Hand Side (RHS) is opposite, unless noted otherwise.

WARNING:

IT IS THE RESPONSIBILITY OF ALL PERSONNEL TO ENSURE WORK HEALTH AND SAFETY REQUIREMENTS ARE MET AT ALL TIMES. ALL PERSONNEL MUST COMPLY WITH ALL WORK HEALTH AND SAFETY REQUIREMENTS AS DEFINED OR RECOMMENDED BY:

- EQUIPMENT OEM INSTALLATION AND OPERATION MANUALS;
- AIRCRAFT MAINTENANCE AND OPERATION MANUALS;
- ASSOCIATED AIRCRAFT MODIFICATION INSTRUCTIONS;
- RELEVANT NAA REGULATIONS AND ADVISORY DOCUMENTATION;
- ORGANISATION MANUALS, INCLUDING NAA ENDORSED OPERATIONAL AND MAINTENANCE MANUALS; AND
- RELEVANT LOCAL, STATE AND FEDERAL GOVERNMENT REQUIREMENTS.

WARNING:

READ THE APPLICABLE MATERIAL SAFETY DATA SHEET (MSDS) FOR ANY MATERIAL/CONSUMABLE USED DURING THE ACCOMPLISHMENT OF THIS SERVICE BULLETIN AND EMPLOY ANY RECOMMENDED PERSONAL PROTECTIVE EQUIPMENT (PPE) CONTAINED THEREIN.

NOTE:

Unless otherwise specified, reference to the GA8/GA8-TC 320 Service Manual and FAA Advisory Circular (AC) 43.13-1B & -2B should be made when carrying out the procedures prescribed in this Service Bulletin. In case of a discrepancy between the Service Manual and the AC, the Service Manual takes precedence.

Part A – Preparation

1. Make the aircraft safe for maintenance by at least isolating the aircraft's electrical system.

Part B – Elevator Hinge Modifications

NOTE:

Refer to Table 4 for the details of each part number.

1. Remove the elevator in accordance with Chapter 27-30-03 of the GA8/GA8-TC 320 Service Manual. Retain hinge bolts, nuts and washers if serviceable. Discard the sliding bushes.

CAUTION:

INTERFERENCE FIT BUSHES CAN BE REMOVED BY DRIVING WITH A DRIFT AND HAMMER, OR BY USING A COMMERCIALY AVAILABLE BEARING REMOVAL TOOL OR BY A TIGHTENING A COMBINATION OF A BOLT, NUT AND PACKING WASHERS TO PUSH THE BUSH OUT.

IF REMOVING A BUSH BY DRIVING DO NOT DAMAGE THE HINGE AND MAKE SURE TO SUPPORT THE OPPOSITE SIDE OF THE HINGE WITH A SOFT MATERIAL SUCH AS TIMBER.

IF USING A BEARING REMOVAL TOOL DO NOT DAMAGE THE HINGE.

2. Carefully remove the interference fit bush from the Hinge. Do a detailed visual inspection of the Hinge lug bore to look for any damage, corrosion or cracks, especially around the grease hole. Use a strong light source and 10x magnification if possible. Note the location of any findings.
3. Increase the diameter of the lug bore to between 0.6245" and 0.6255". Maintain the original lug centreline and bore perpendicularity as shown in Figure 2, and make sure the lug bore has a maximum surface roughness of 32 Ra.

NOTE:

To enlarge the lug bore, drill through with a 39/64" drill and finish the hole with a 5/8" hand or machine reamer. Or, a 5/8" diameter end mill can be used with a guide block to enlarge and finish the bore in one operation.

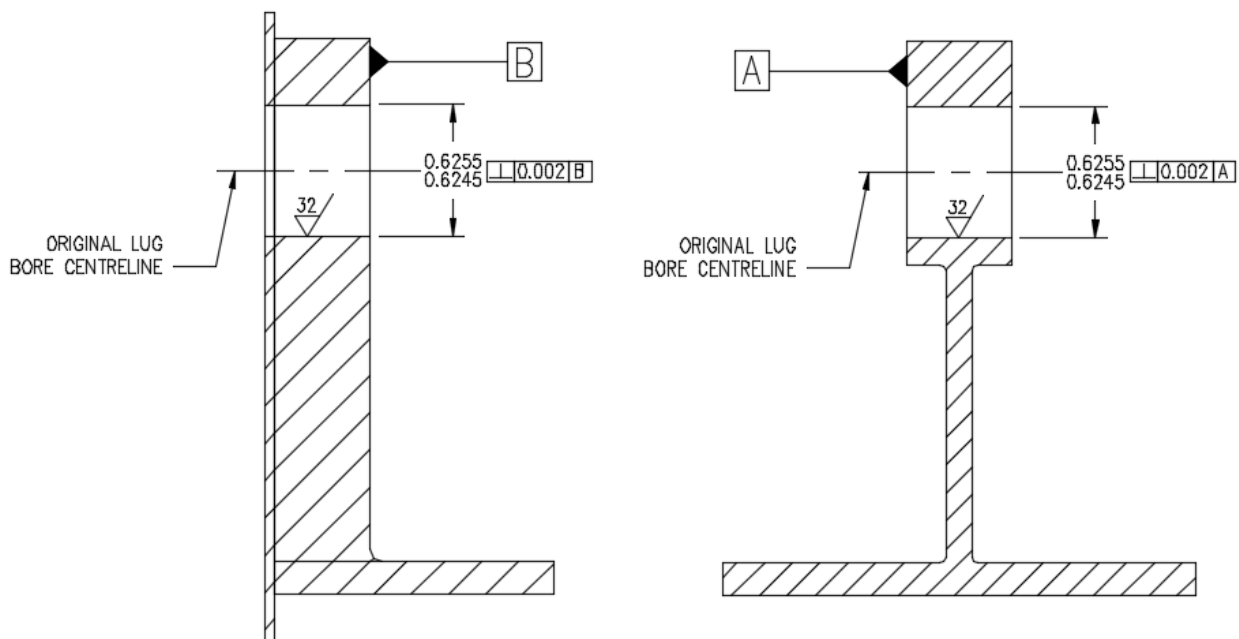
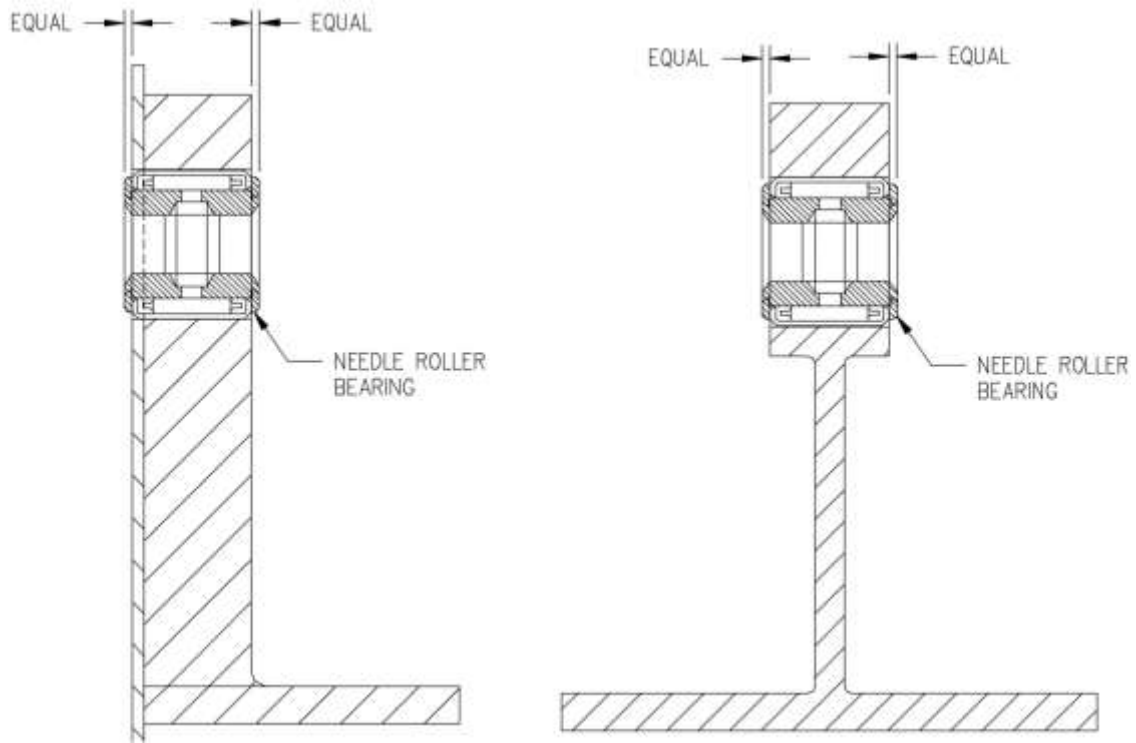

**Figure 2 – Modified Hinge and lug dimensions (in inches)
Outboard Hinge (left), Centre and Inboard Hinge (right)**

4. Do a detailed visual inspection of the oversized lug bore. Look for damage, corrosion or cracks using a strong light source and 10x magnification if possible. If any cracks, corrosion or damage is found the Hinge must be replaced. Contact GippsAero if assistance is required.

If the lug bore is damage free, continue.

5. Clean bore of lug using a cleaning solvent and lint free rag. Make sure bore is free of any foreign objects.
6. Install needle roller bearing by pressing into lug bore. Make sure the bearing is in the centre of the bore as shown in Figure 3.



**Figure 3 – Bearing installation requirements
Outboard Hinge (left), Centre and Inboard Hinge (right)**

7. Lubricate bore of bearing with a general purpose airframe grease per MIL-PRF-23827 Type 1 (such as Aeroshell 33©) or MIL-PRF-81322 (such as Aeroshell 22©).
8. Install removed Elevator by locating in position and:
 - 8.1. Insert serviceable hinge bolt, nut and washers through Centre Hinge using 2 (two) quantity washers (Item 2) as identified in Figure 4 as 'new washers'.

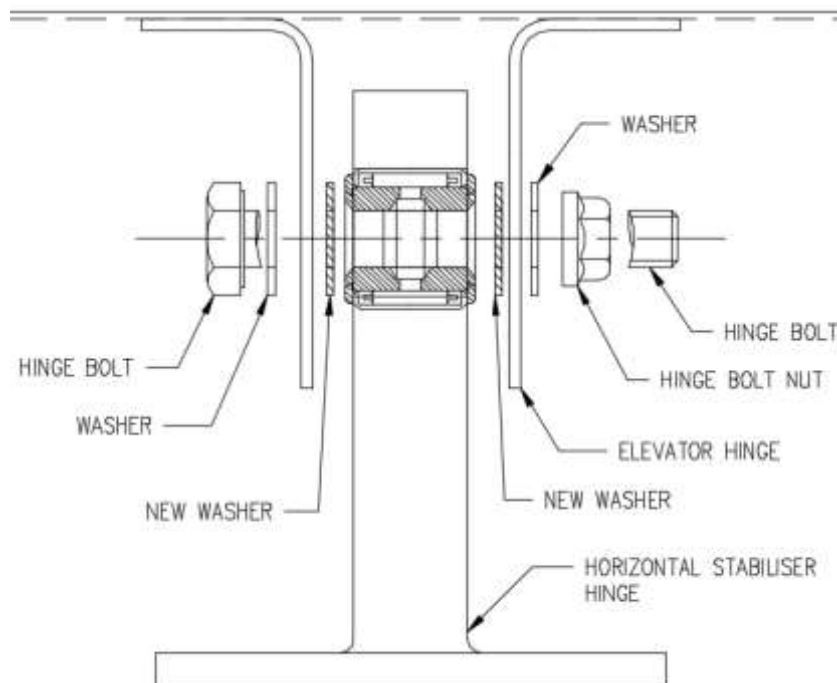

Figure 4 – Centre Hinge Installation

- 8.2. Torque nut per Chapter 20 of the GA8/GA8-TC 320 Service Manual.
- 8.3. Temporarily locate Inboard and Outboard hinge bolts through elevator and horizontal stabiliser hinges. Measure the gaps between the end washers of the needle roller bearing and inside faces of the Inboard elevator hinges as shown in Figure 5.

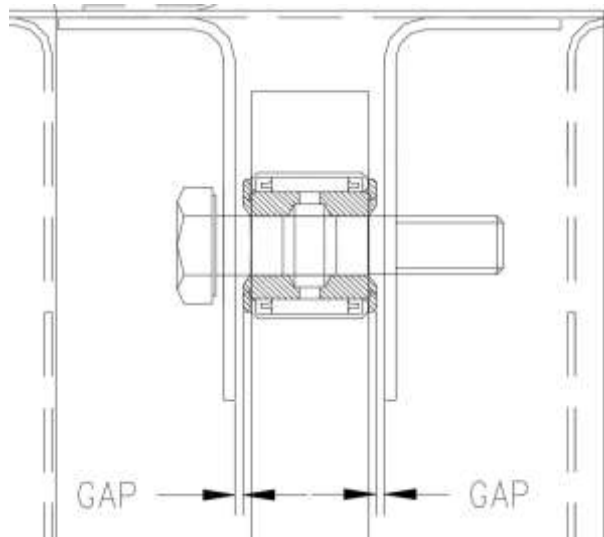

Figure 5 – Measurement of gap for Inboard Hinge

- 8.4. Select any combination of NAS1149-04 washers with enough thickness to pack the measured gaps $+0.000''/-0.016''$.

NOTE:

Operators or Maintenance Providers may choose to locally manufacture custom spacers rather than using washers. If so, use 4130 steel bar per MIL-S-6758 or AMS-S-6758 and the dimensions shown in Figure 8.

- 8.5. Install serviceable hinge bolt, nut and washers through Inboard Hinge using the number of washers determined in Step 8.4 as shown in Figure 6.

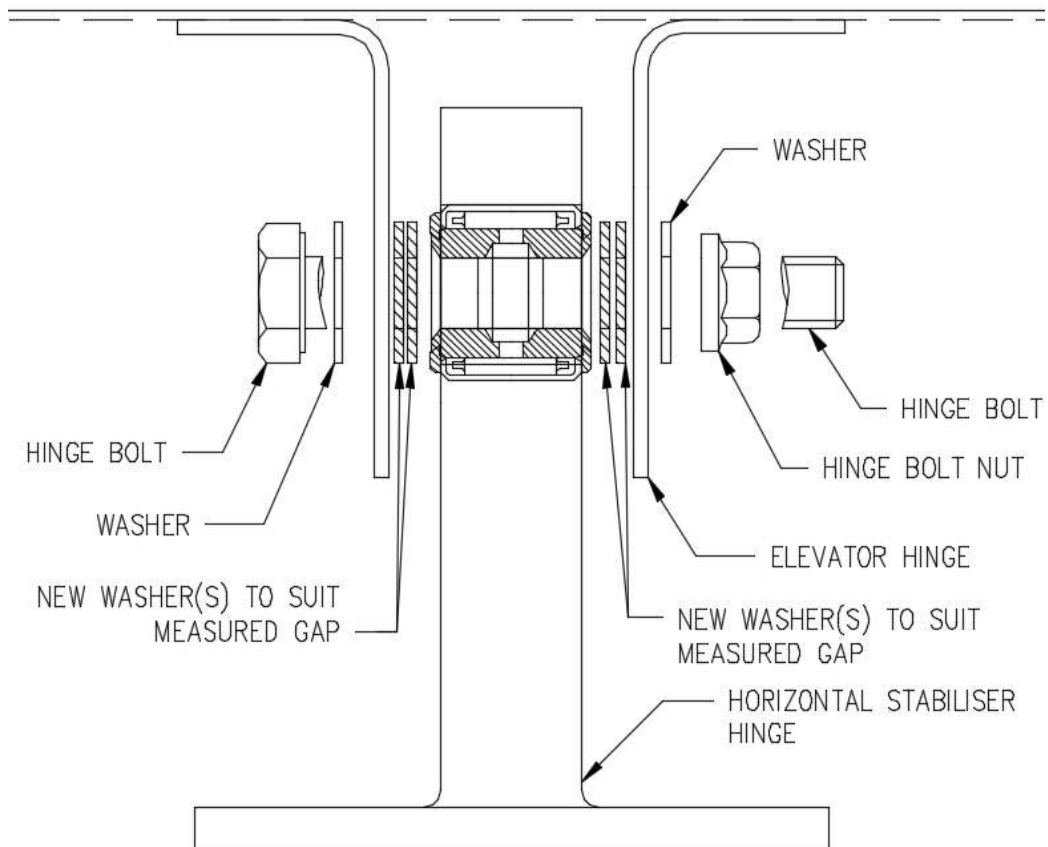

Figure 6 – Inboard Hinge Installation

- 8.6. Torque Inboard Hinge nuts per Chapter 20 of the GA8/GA8-TC 320 Service Manual.
- 8.7. Measure the gaps between the end washers of the needle roller bearing and inside faces of the Outboard elevator hinges as shown in Figure 7.

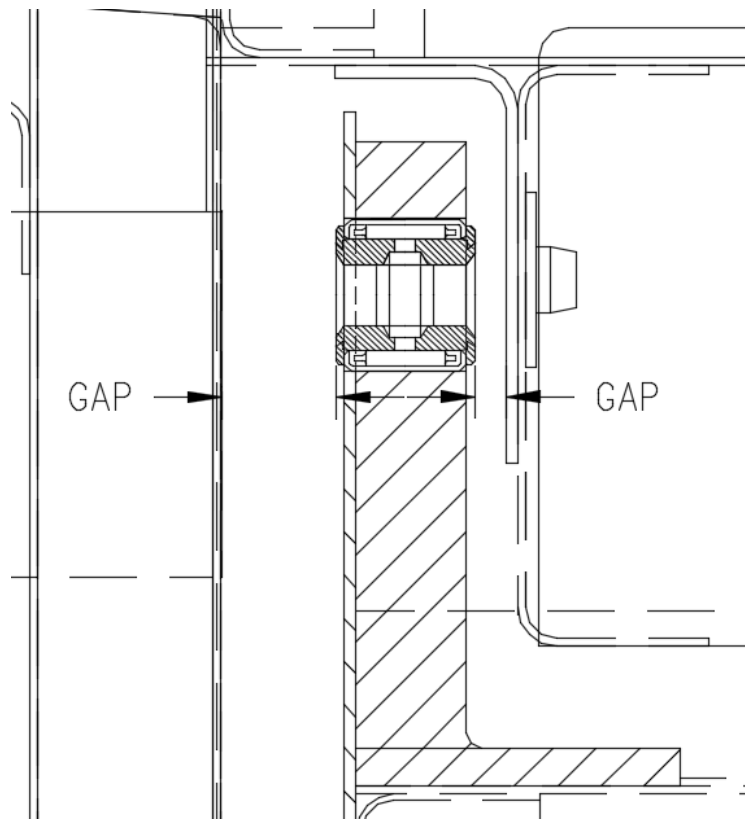

Figure 7 – Measurement of gaps for Outboard Hinge

8.8. Select any combination of NAS1149-04 washers with enough thickness to pack the measured gap on the inboard side of the Hinge $+0.000"/>-0.016$ ".

NOTE:

Operators or Maintenance Providers may choose to locally manufacture custom spacers rather than using washers. If so, use 4130 steel bar per MIL-S-6758 or SAE-AMS-S-6758 and the dimensions shown in Figure 8.

8.9. Make a spacer to suit the gap on the outboard side of the Outboard Hinge to the dimensions in Figure 8. Make the spacer from 4130 round bar per MIL-S-6758 or AMS-S-6758 and break all sharp edges.

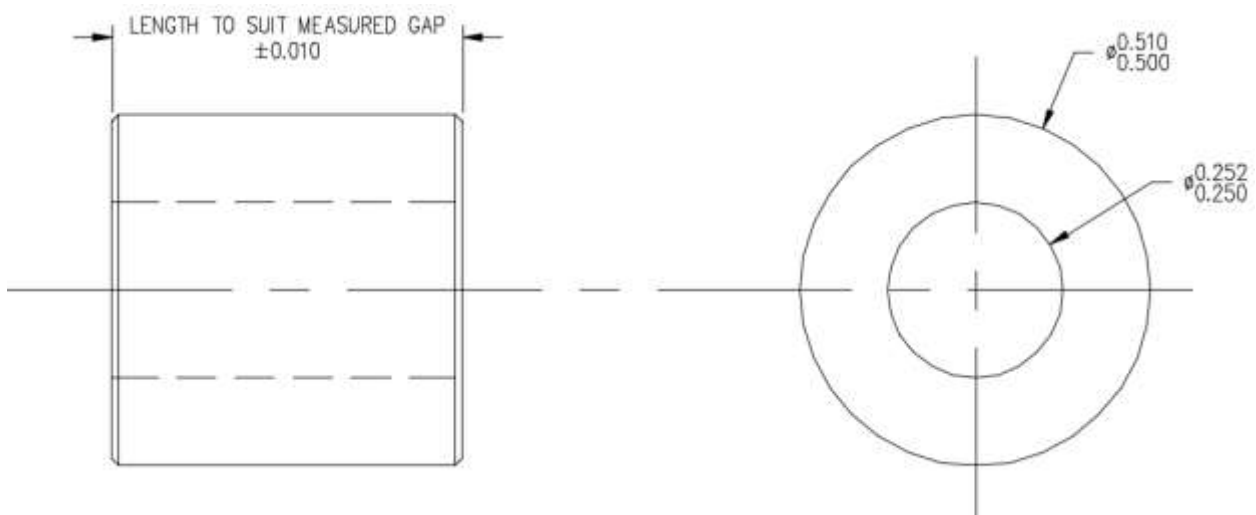

Figure 8 – Outboard Hinge spacer (dimensions in inches) change ID

8.10. Install serviceable hinge bolt, nut and washers through Outboard Hinge using the number of washers determined in Step 8.8 and spacer manufactured under Step 8.9 as shown in Figure 9.

8.11. Torque Hinge bolt per Chapter 20 of the GA8/GA8-TC 320 Service Manual.

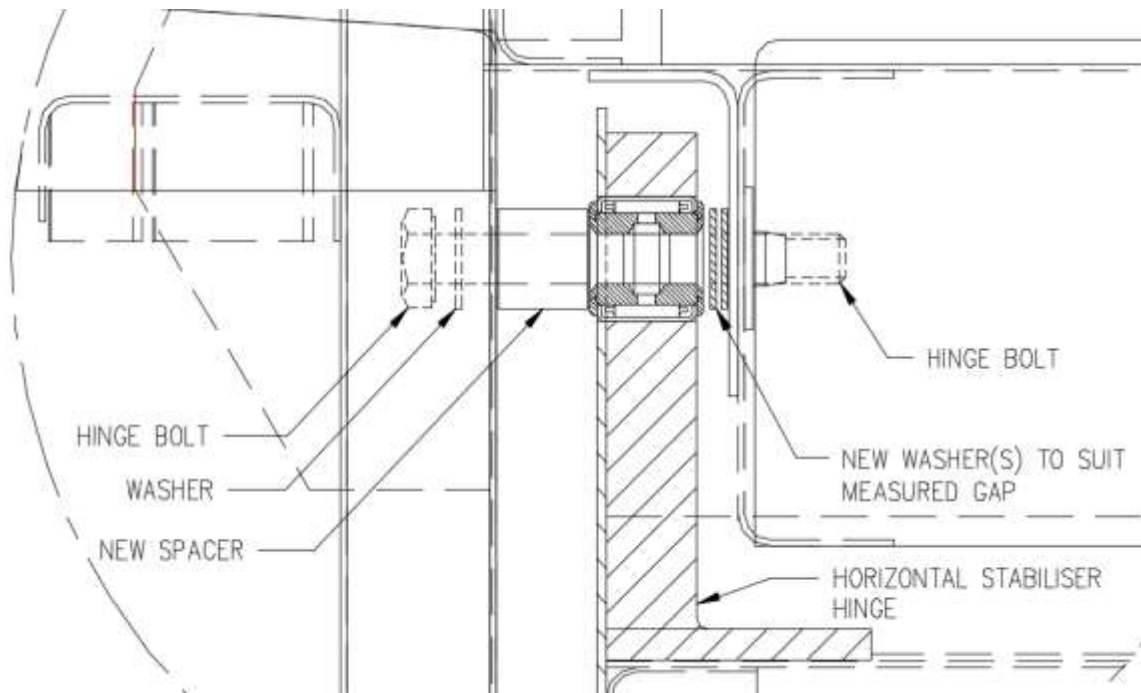

Figure 9 – Installation of Outboard Hinge

WARNING:

ELEVATOR MUST MOVE SMOOTHLY THROUGH FULL TRAVEL. IF ELEVATOR OPERATION IS RESTRICTED, CHECK INSTALLATION OF ROLLER BEARINGS AND PACKING WASHERS/SPACERS.

9. Do a functional check of elevator. Move elevator through full travel from up to down and make sure elevator moves smoothly and does not bind.
10. If elevator operation is satisfactory, continue elevator installation in accordance with Chapter 27-30-03 of the GA8/GA8-TC 320 Service Manual.
11. If required, do Elevator System Rigging per Chapter 27-30-09 of the GA8/GA8-TC 320 Service Manual.

Part C – Rudder Hinge Modifications

NOTE:

Refer to Table 4 for the details of each part number.

1. Remove the rudder in accordance with Chapter 27-20-10 of the GA8/GA8-TC 320 Service Manual. Retain hinge bolts, nuts and washers if serviceable. Discard the sliding bushes.

CAUTION:

INTERFERENCE FIT BUSHES CAN BE REMOVED BY DRIVING WITH A DRIFT AND HAMMER, OR BY USING A COMMERCIALY AVAILABLE BEARING REMOVAL TOOL OR BY TIGHTENING A COMBINATION OF A BOLT, NUT AND PACKING WASHERS TO PUSH THE BUSH OUT.

IF REMOVING A BUSH BY DRIVING DO NOT DAMAGE THE HINGE AND MAKE SURE TO SUPPORT THE OPPOSITE SIDE OF THE HINGE WITH A SOFT MATERIAL SUCH AS TIMBER.

IF USING A BEARING REMOVAL TOOL DO NOT DAMAGE THE HINGE.

2. Carefully remove the interference fit bush from each Hinge. Do a detailed visual inspection of the Hinge lug bore to look for any damage, corrosion or cracks, especially around the grease hole. Use a strong light source and 10x magnification if possible. Note the location of any findings.
3. Increase the diameter of the lug bore to between 0.6245" and 0.6255". Maintain the original lug centreline and bore perpendicularity as shown in Figure 2, and make sure the lug bore has a maximum surface roughness of 32 Ra.

NOTE:

To enlarge the lug bore, first drill through with a 39/64" drill. Finish the hole with a 5/8" hand or machine reamer. Alternatively, a 5/8" end mill can be used with a guide block to enlarge and finish the bore in one operation.

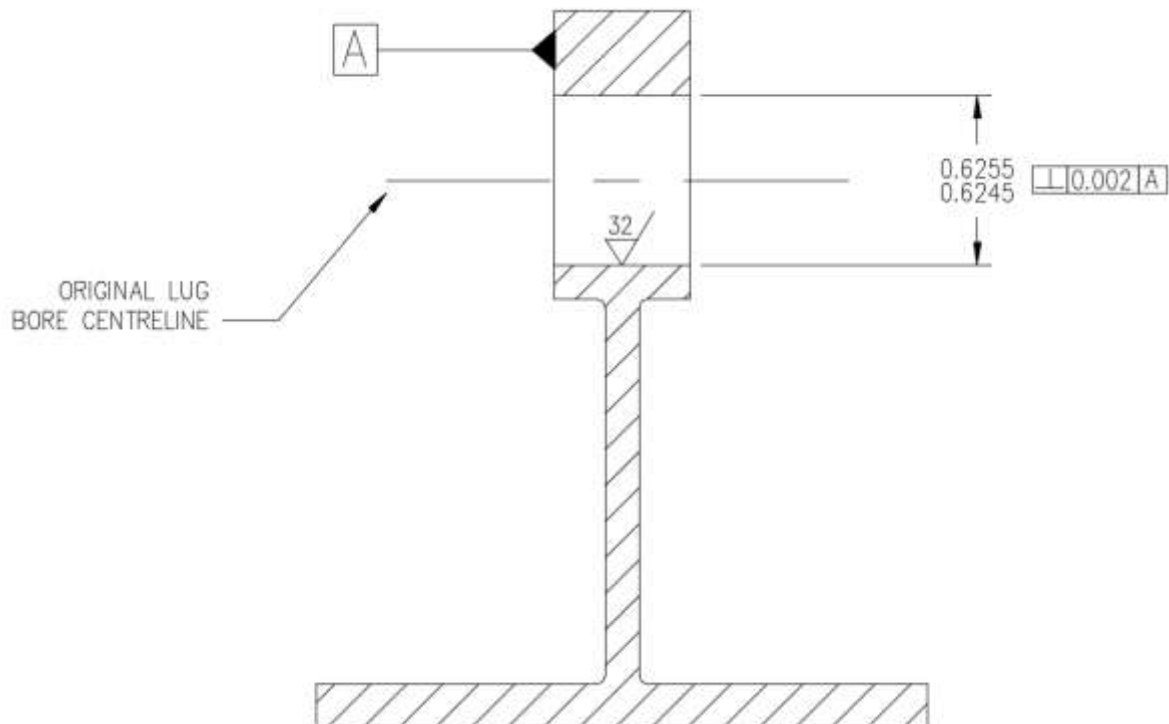

Figure 10 – Hinge cross section and lug dimensions (in inches)

4. Do a detailed visual inspection of the oversized lug bore. Look for damage, corrosion or cracks using a strong light source and 10x magnification if possible. If any cracks, corrosion or damage is found the Hinge must be replaced. Contact GippsAero if assistance is required.

If the lug bore is damage free, continue.

5. Clean bore of lug using a cleaning solvent and lint free rag. Make sure bore is free of any foreign objects.

6. Install needle roller bearing by pressing into lug bore. Make sure the bearing is in the centre of the bore as shown in Figure 3.
7. Lubricate bore of bearings with a general purpose airframe grease per MIL-PRF-23827 Type 1 (such as Aeroshell 33©) or MIL-PRF-81322 (such as Aeroshell 22©).
8. Install removed Rudder by locating in position and:
 - 8.1. Temporarily insert serviceable Upper and Lower hinge bolts through Rudder and Vertical Stabiliser Hinges. Measure the gaps between the end washer of the needle roller bearings and upper faces of the Upper and Centre rudder hinges as shown in Figure 11.

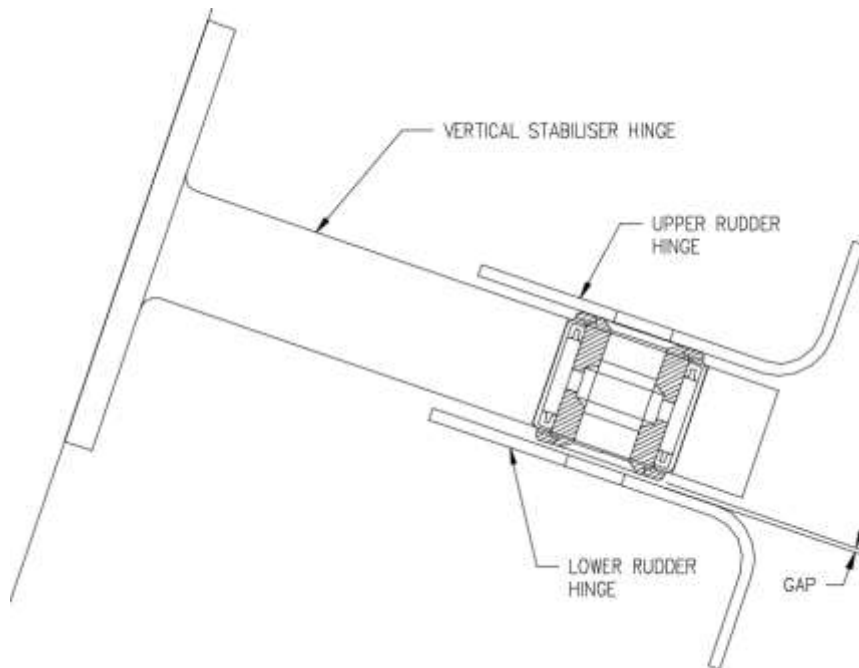

Figure 11 – Measurement of gaps for Upper and Centre Rudder Hinges

- 8.2. Select any combination of NAS1149-04 washers with enough thickness to pack the measured gap on the lower side of the Vertical Stabiliser Hinge $+0.000''/-0.016''$.
- 8.3. Install serviceable hinge bolt, nut and washers through Upper and Centre Hinges using the number of washers determined in Step 8.2.

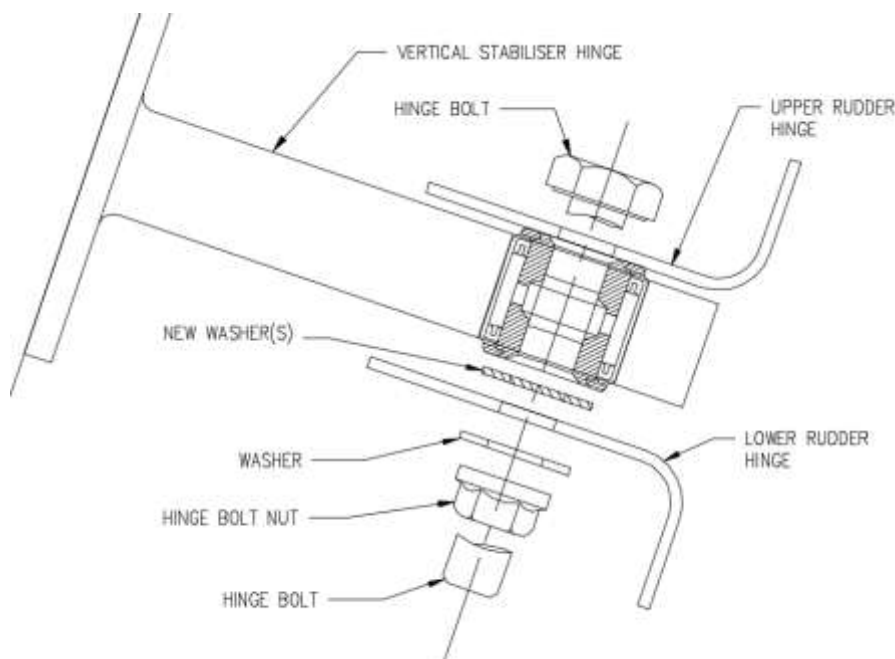

Figure 12 – Upper and Centre Rudder Hinge installation

- 8.4. Torque all Hinge nuts per Chapter 20 of the GA8/GA8-TC 320 Service Manual.

WARNING:

RUDDER MUST MOVE SMOOTHLY THROUGH FULL TRAVEL. IF RUDDER OPERATION IS RESTRICTED, CHECK INSTALLATION OF ROLLER BEARINGS AND PACKING WASHERS.

INSTALLATION OF ROLLER BEARINGS WILL MOVE RUDDER UP. CHECK CONNECTION OF RUDDER CONTROL CABLES CAREFULLY FOR ALIGNMENT

9. Do a functional check of rudder. Move rudder through full travel from left to right and make sure rudder moves smoothly and does not bind.
10. If rudder operation is satisfactory, continue rudder installation in accordance with Chapter 27-20-15 of the GA8/GA8-TC 320 Service Manual.

Documentation:

Update aircraft log book to reflect incorporation of this Service Bulletin.

Continuing Airworthiness:

There are no new Instructions for Continued Airworthiness associated with this Service Bulletin

Compliance Notice:

Complete the Document Compliance Notice and return to GippsAero by mail, fax or email.

DOCUMENT COMPLIANCE NOTICE



A Mahindra Aerospace Company

Document:

SB-GA8-2018-177

Issue 1

Aircraft Serial Number: GA8-_____

Service Bulletin SB-GA8-2018-177, Issue 1 has been incorporated in the above aircraft.

Date of Incorporation: _____

Signed

Print Name: _____

If this Service Bulletin requires any inspections be carried out, describe the result of these inspections:

Please post, fax or email this compliance notice to:

GippsAero Technical Services
P.O. Box 881
Morwell Victoria 3840
Australia
Fax.: +61 03 5172 1201
Email: aircraft.techpubs@mahindraaerospace.com