



A Mahindra Aerospace Company

SB-GA8-2016-163

Issue 1

OPTIONAL

PO Box 881, Morwell, Victoria 3840, Australia
Ph + 61 (0) 3 5172 1200
Fax + 61 (0) 3 5172 1201
www.mahindraaerospace.com

Service Bulletin

Subject:

Horizontal Stabiliser Attachment Area Inspection and Reinforcement

Applicability:

This Service Bulletin is applicable to the aircraft identified in Table 1.

Table 1 – Applicability

AIRCRAFT	SERIAL NUMBER(s)
GA8	All
GA8-TC 320	All

Additional model numbers may be added at future revisions.

Amendments:

Issue 1: Initial Issue

Background:

Cracks have been reported in the LH/RH Tailcone Skins, P/N GA8-538021-161/-162 and Interior Aft Skin Doublers, P/N GA8-538021-309/-310 around the attachment of the Horizontal Stabiliser Pivots, P/N GA8-538021-233/-234.

This Service Bulletin (SB) provides a repair, part replacement and reinforcement scheme for aircraft that develop these cracks in the Tailcone.

Operators with aircraft found with cracks shall do the repair, part replacement and reinforcement schemes in Parts C, D and E of this SB.

Operators without evidence of cracking may choose to do the reinforcement scheme in Part E as a preventative measure. In this case GippsAero **recommends** repeating the inspections in Part B at 100 flight hour intervals.

Compliance:

The accomplishment instructions contained within this Service Bulletin are optional and may be incorporated at the Operator's, Owner's or Maintenance Provider's discretion.

Weight and Balance:

The effect of this Service Bulletin's incorporation on the aircraft's weight and balance is negligible.

Electrical Load Analysis:

This Service Bulletin's incorporation has no effect on the aircraft's electrical load analysis.

Approval:

The airframe modification and repair described in this Service Bulletin has been approved pursuant to Australian Civil Aviation Safety Regulation 21.095 (1998). GippsAero Reference GAE11#1815.

Parts:

The following parts are required to accomplish this Service Bulletin.

Table 2 – Parts for Part D

ITEM	PART No.	DESCRIPTION	QTY	REMARKS
1	GA8-538021-309	Interior Aft Skin Doubler, LHS	1	New part
2	GA8-538021-310	Interior Aft Skin Doubler, RHS	1	New part
3	MS20470AD4-*	Rivet, Solid, Universal Head	14	Determine grip length upon installation

Table 3 – Parts for Part E

ITEM	PART No.	DESCRIPTION	QTY	REMARKS
5	GA8-2016-163-1	Reinforcement Doubler, LHS	1	Locally fabricate from 2024-T3, 0.032" thick per SAE-AMS-QQ-A-250/5
6	GA8-2016-163-2	Reinforcement Doubler, RHS	1	Locally fabricate from 2024-T3, 0.032" thick per SAE-AMS-QQ-A-250/5
7	GA8-2016-163-3	Shim	2	Locally fabricate from 2024-T3, 0.050" thick per SAE-AMS-QQ-A-250/5
8	MS20470AD4-*	Rivet, Solid, Universal Head	18	Determine grip length upon installation
9	NAS1097AD3-*	Rivet, Solid, 100° Flush Shear Head	4	Determine grip length upon installation
10	NAS6603-7	Bolt, Hex Head, Close Tolerance	18	See Step 10 of PART E before procurement
11	NAS6603-8	Bolt, Hex Head, Close Tolerance	18	See Step 10 of PART E before procurement

Table 4 – Consumables

ITEM	PART No.	DESCRIPTION	QTY	REMARKS
12	MIL-DTL5541F	Chemical Conversion Coating	-	QPL for MIL-DTL-81706C
13	MIL-PRF-23377F	Aircraft Primer	-	Alternate FED-SPEC-TT-P-1757B

Parts Availability:

New parts can be obtained directly from GippsAero.

Tel: +61 (0)3 5172 1200

Fax: +61 (0)3 5172 1201

Email: aircraft.support@mahindraaerospace.com

Labour:

16 man hours should be allocated for completing the work detailed in this Service Bulletin. This time does not include set up etc.

Warranty:

Aircraft covered by warranty may claim the direct cost of incorporating the requirements of this Service Bulletin by contacting GippsAero Customer Service:

Tel: +61 (0)3 5172 1200

Fax: +61 (0)3 5172 1201

Email: aircraft.warranty@mahindraaerospace.com

Overview

Production Configurations

An improvement to the assembly sequence of the Tailcone Skin, Aft Bulkhead and Interior Aft Skin Doublers has been implemented which improves the fit of the Elevator Travel Stops. Figure 1 and Figure 2 highlight the difference: the Doubler flange is either above or below the top Aft Bulkhead flange. Refer to these images when completing **Part E** of this Service Bulletin.

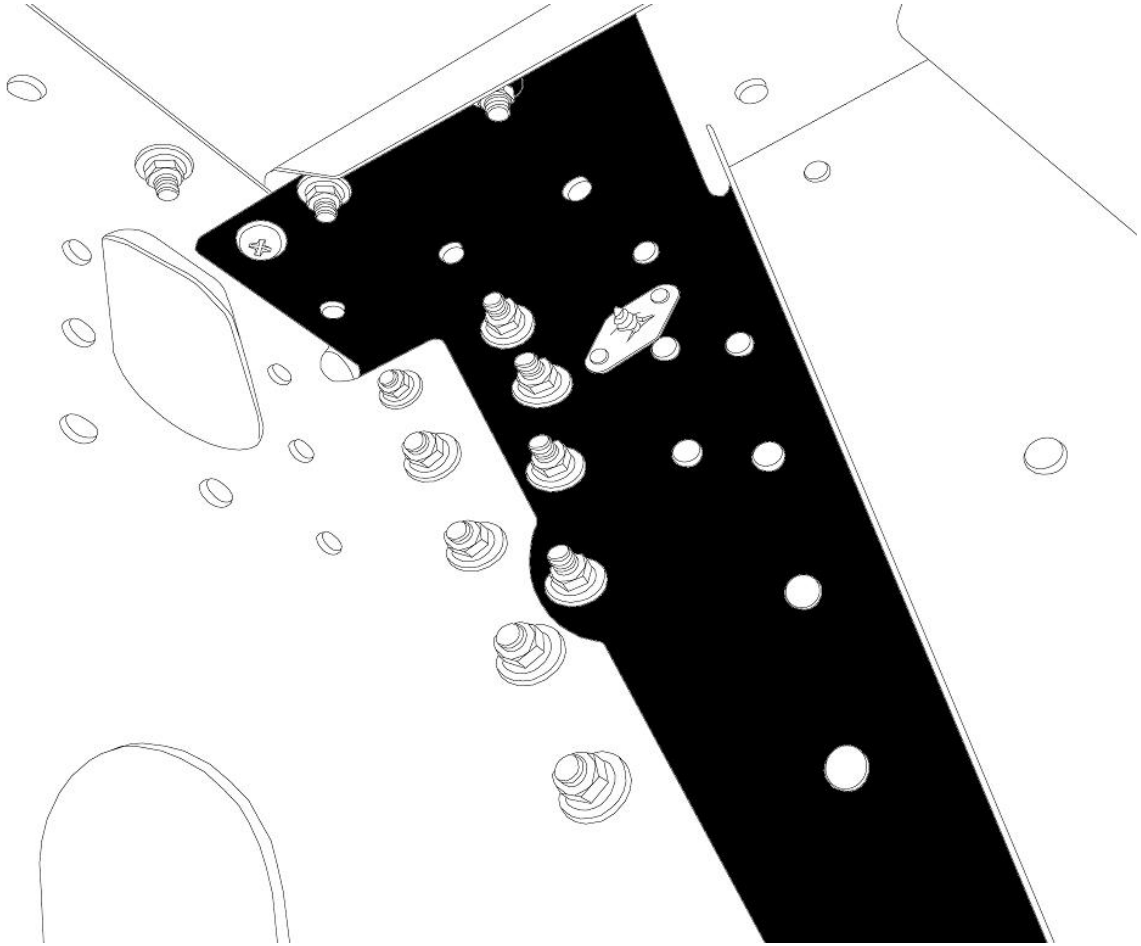

Figure 1 – Original Production Configuration of LHS Interior Aft Skin Doubler
(Doubler highlighted)

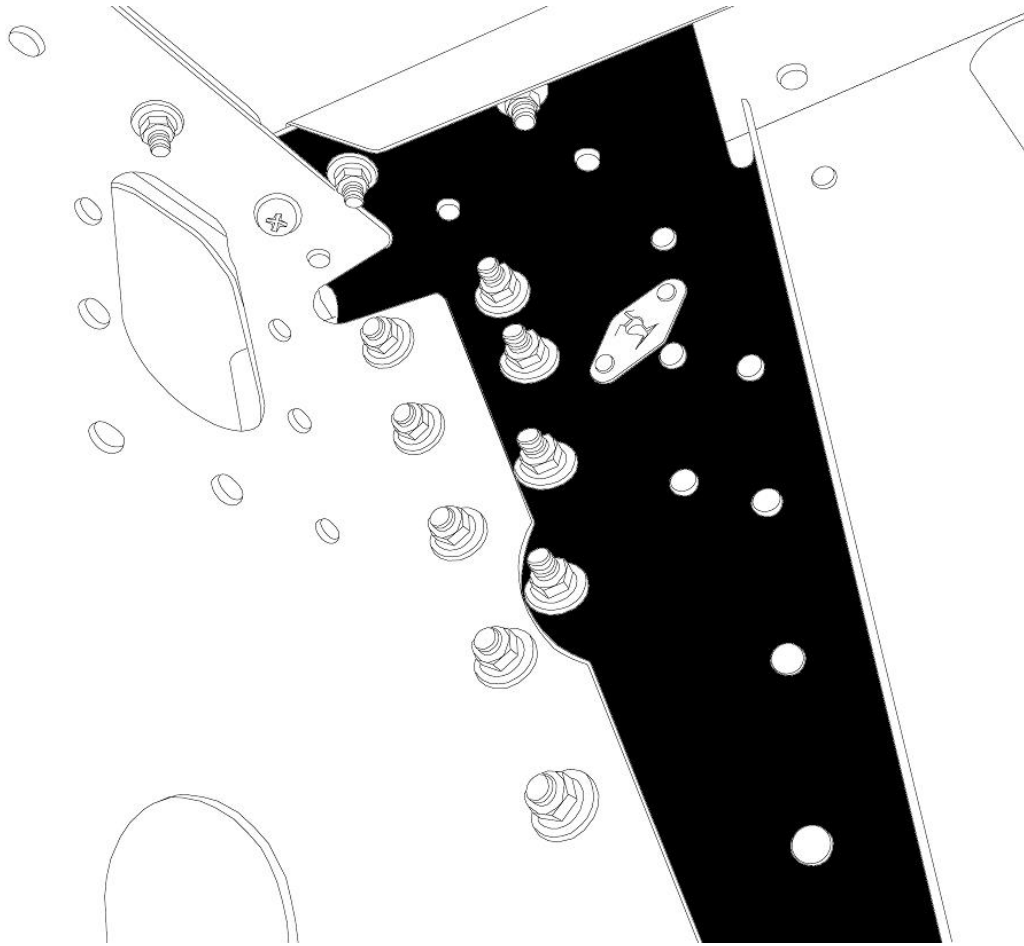

Figure 2 – New Production Configuration of LHS Interior Aft Skin Doubler
(Doubler highlighted)

A production improvement has also been implemented which alters the shape of the Elevator Travel Stiffening Plates. Figure 3 highlights an original configuration part, new production items will vary however their fit remains unchanged.

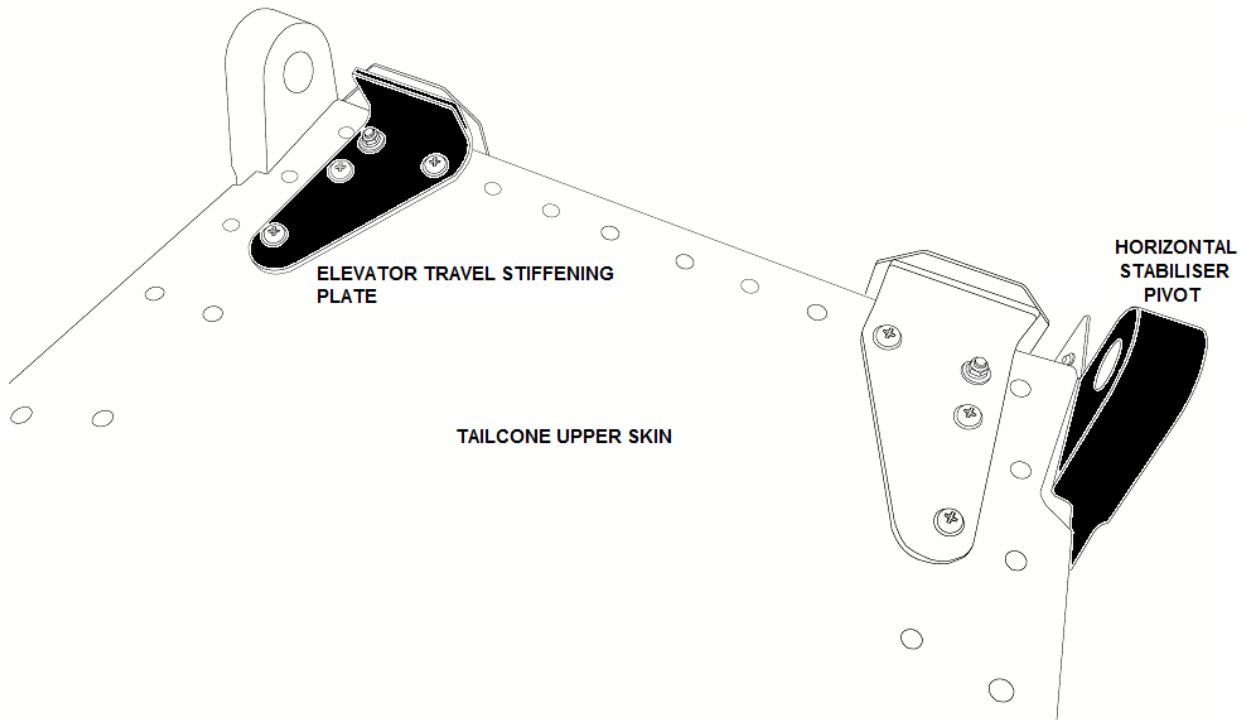
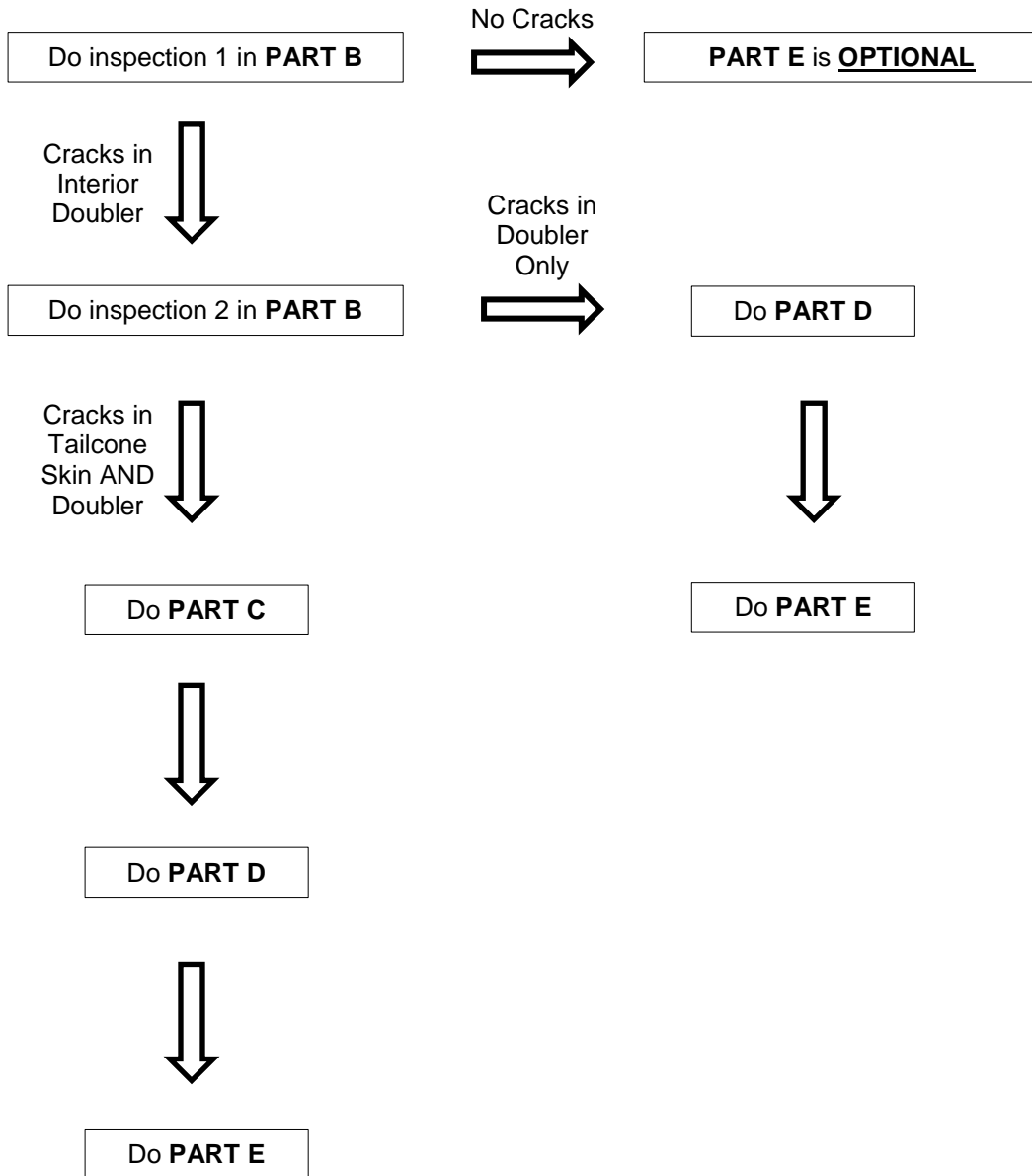

Figure 3 – Overview of Tailcone Components
(Vertical Stabiliser removed)

Procedure



Accomplishment Instructions:

The following instructions are applicable to the Left Hand Side (LHS) of the aircraft; the Right Hand Side (RHS) is opposite, unless noted otherwise.

WARNING:

IT IS THE RESPONSIBILITY OF ALL PERSONNEL TO ENSURE WORK HEALTH AND SAFETY REQUIREMENTS ARE MET AT ALL TIMES. ALL PERSONNEL MUST COMPLY WITH ALL WORK HEALTH AND SAFETY REQUIREMENTS AS DEFINED OR RECOMMENDED BY:

- EQUIPMENT OEM INSTALLATION AND OPERATION MANUALS;
- AIRCRAFT MAINTENANCE AND OPERATION MANUALS;
- ASSOCIATED AIRCRAFT MODIFICATION INSTRUCTIONS;
- RELEVANT NAA REGULATIONS AND ADVISORY DOCUMENTATION;
- ORGANISATION MANUALS, INCLUDING NAA ENDORSED OPERATIONAL AND MAINTENANCE MANUALS; AND
- RELEVANT LOCAL, STATE AND FEDERAL GOVERNMENT REQUIREMENTS.

WARNING:

READ THE APPLICABLE MATERIAL SAFETY DATA SHEET (MSDS) FOR ANY MATERIAL/CONSUMABLE USED DURING THE ACCOMPLISHMENT OF THIS SERVICE BULLETIN AND EMPLOY ANY RECOMMENDED PERSONAL PROTECTIVE EQUIPMENT (PPE) CONTAINED THEREIN.

NOTE:

Unless otherwise specified, reference to the GA8/GA8-TC 320 Service Manual and FAA Advisory Circular (AC) 43.13-1B & -2B should be made when carrying out the procedures prescribed in this Service Bulletin. In case of a discrepancy between the Service Manual and the AC, the Service Manual takes precedence.

NOTE:

All dimensions are in inches unless noted otherwise.

NOTE:

All rivet codes are per NAS 523.

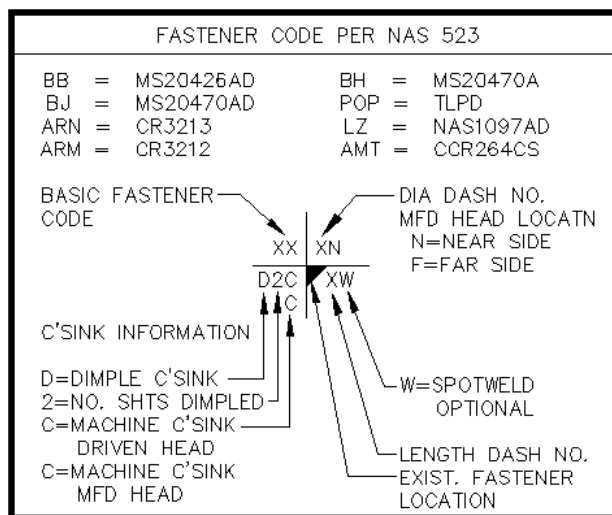

Part A – Preparation

1. Remove the Pilot's Seat in accordance with Section 25-10-01 of the applicable aircraft Service Manual.
2. Remove all floor coverings from the Pilot's foot well.
3. Make the aircraft safe for maintenance by as a minimum disconnecting the electrical leads from the aircraft battery. Ensure to remove the negative terminal first and then remove the battery from the aircraft.
4. Remove all the three aft Tailcone access panels and retain.

Part B – Inspection

1. Do a detailed visual inspection, using at least a strong light source, of the internal surface of the LHS and RHS Interior Aft Skin Doublers around the fasteners attaching the Horizontal Stabiliser Pivots and Elevator Travel Stiffening Plates. Concentrate inspections around the fasteners highlighted in Figure 4 and look for cracks as shown in Figure 5.
 - 1.1. If cracking is found in the Doublers, note locations and continue to Step 2.
 - 1.2. If no cracking is found in the Doublers, **Part E** of this Service Bulletin **may** be performed as a preventative measure.

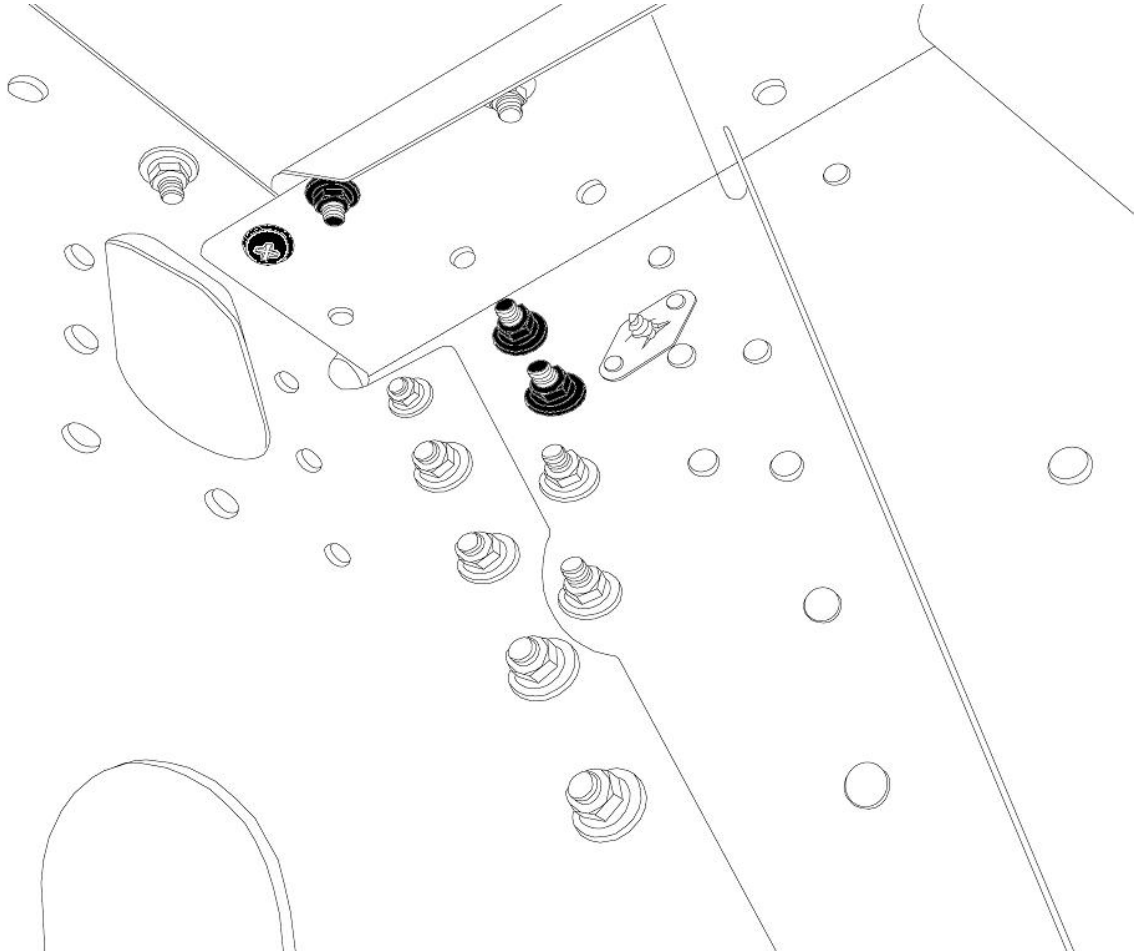

Figure 4 – Inspection Areas

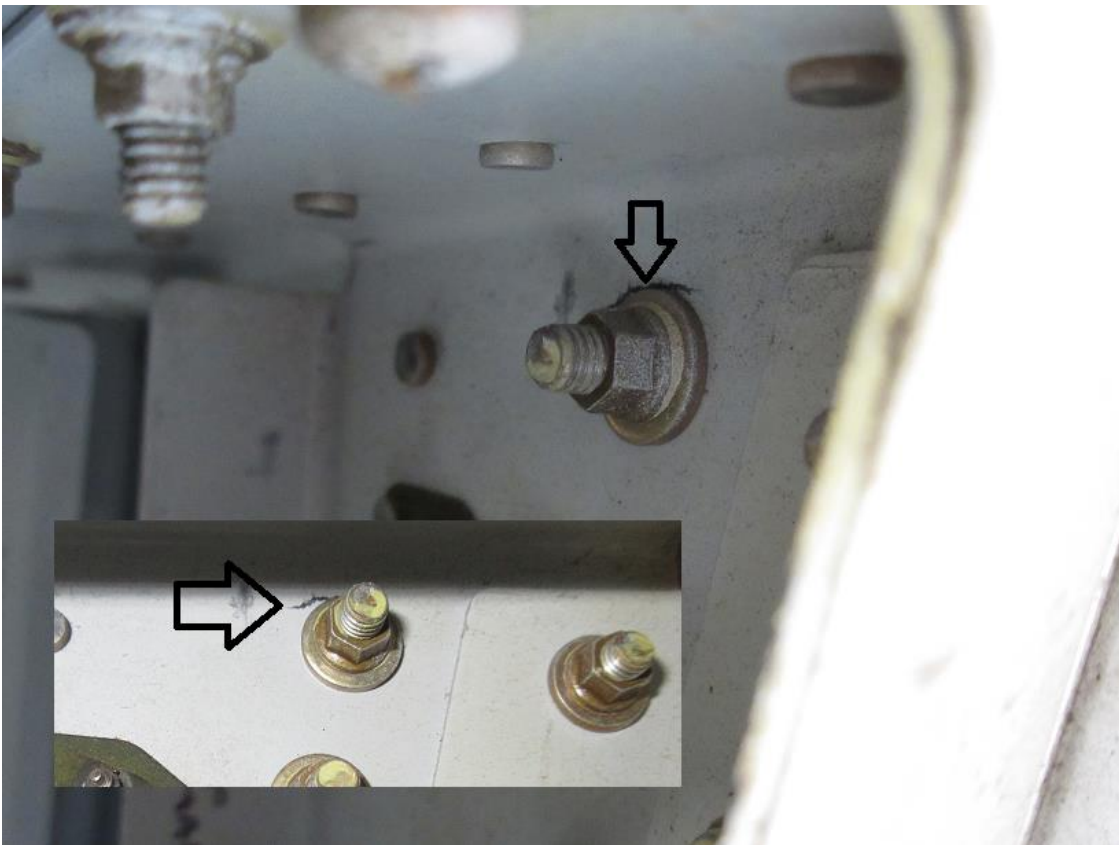
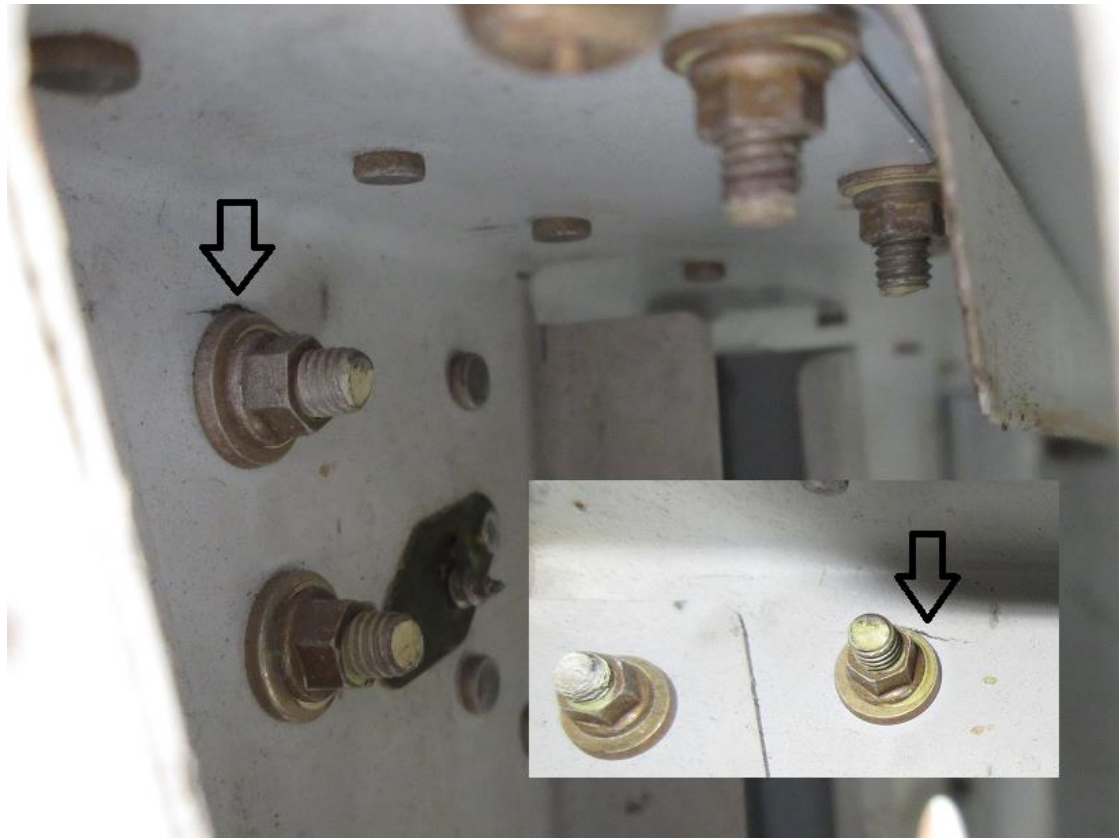

Figure 5 – Typical Cracks

3. Remove the Horizontal Stabiliser in accordance with Chapter 55-10-00 of the applicable aircraft Service Manual.

CAUTION:

DISCARD ALL FASTENERS REMOVED FROM HORIZONTAL STABILISER PIVOTS. IF CRACKS ARE FOUND, FASTENERS MAY HAVE BEEN OVERLOADED.

4. Remove LHS and RHS Horizontal Stabiliser Pivots. Discard attaching fasteners.
5. Do a general visual inspection of the Trim Jack and its supporting structure:
 - 5.1. Check the jack screw for sufficient lubrication;
 - 5.2. Check the jack screw for abnormal wear and axial play by pushing and pulling; and
 - 5.3. Check the supporting structure for any evidence of cracking or permanent deformation.Contact GippsAero if the Trim Jack has excessive wear or axial play or the trim jack structure is damaged.
6. Do a detailed visual inspection, using at least 10x magnification and a strong light source, of the external bend radius of the LHS and RHS Tailcone Skins under the Horizontal Stabiliser Pivots as highlighted in Figure 6.
 - 6.1. If cracking is found in the Tailcone Skins, note locations and do **Part C, Part D and Part E** of this Service Bulletin.
 - 6.2. If no cracking is found in the Tailcone Skins, do **Part D and Part E** of this Service Bulletin.

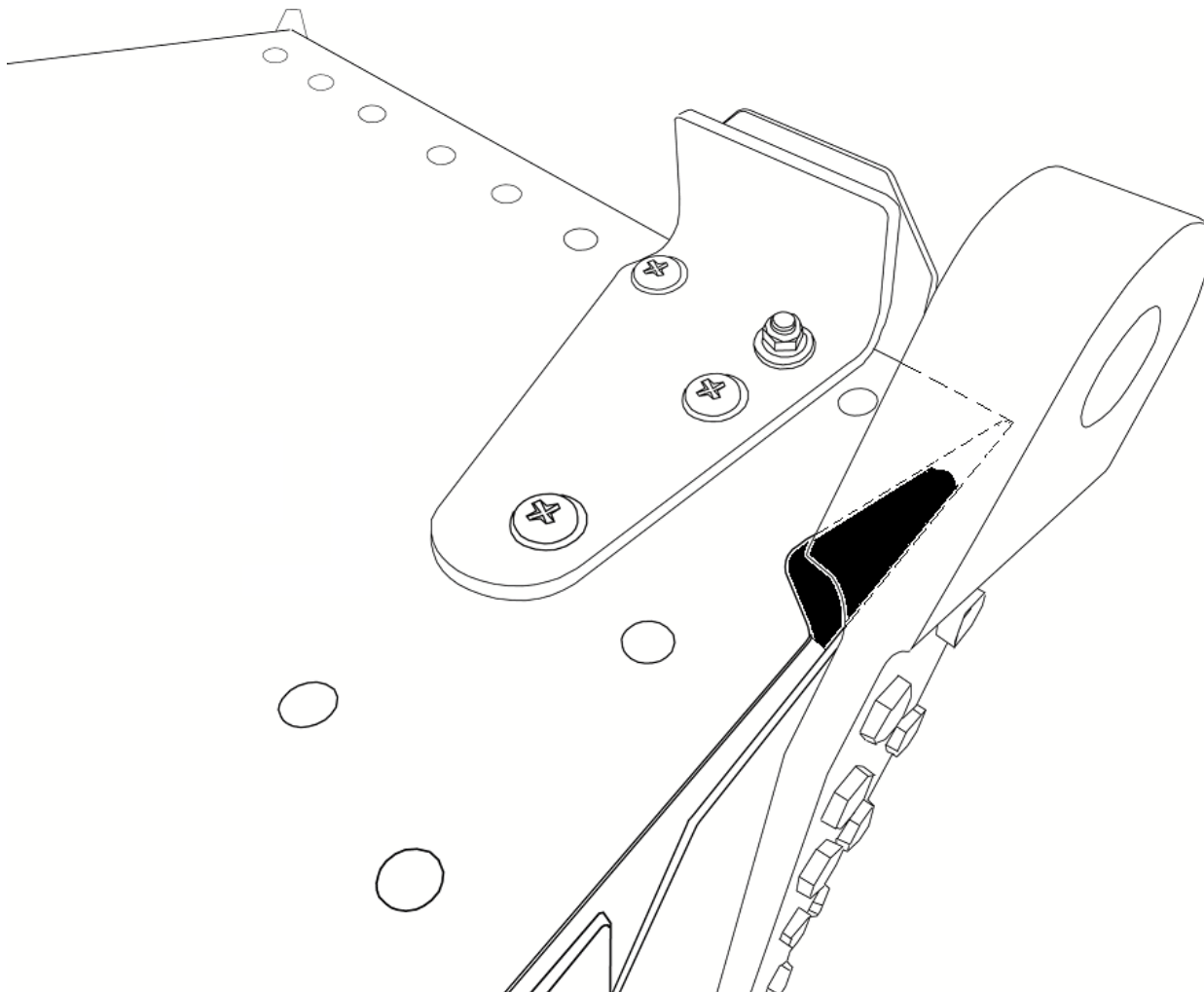

Figure 6 – Tailcone Skin Inspection Area
(LHS shown; RHS typical)

Part C – Repair of Tailcone Skins

These repair procedures apply if cracks are discovered in the LHS or RHS Tailcone Skins.

1. Do a detailed visual inspection of any cracks in the external bend radius of the LHS and RHS Tailcone Skins under the Horizontal Stabiliser Pivots. Determine the crack length and find the visible ends of the crack.

CAUTION:

THE MAXIMUM CRACK LENGTH THAT CAN BE REPAIRED IS 1.0" (25.4 MM). IF ANY CRACK EXCEEDS THIS LENGTH, CONTACT GIPPSAERO

2. Determine if the crack is repairable. A repairable crack:
 - has a maximum length of 1.0" (25.4mm); and
 - is within the 1.5" (38.1mm) long repair zone shown in Figure 7; and
 - is within the 0.5" (12.7mm) wide repair zone shown in Figure 8.

If the crack(s) is/are outside these limits, contact GippsAero for further information.

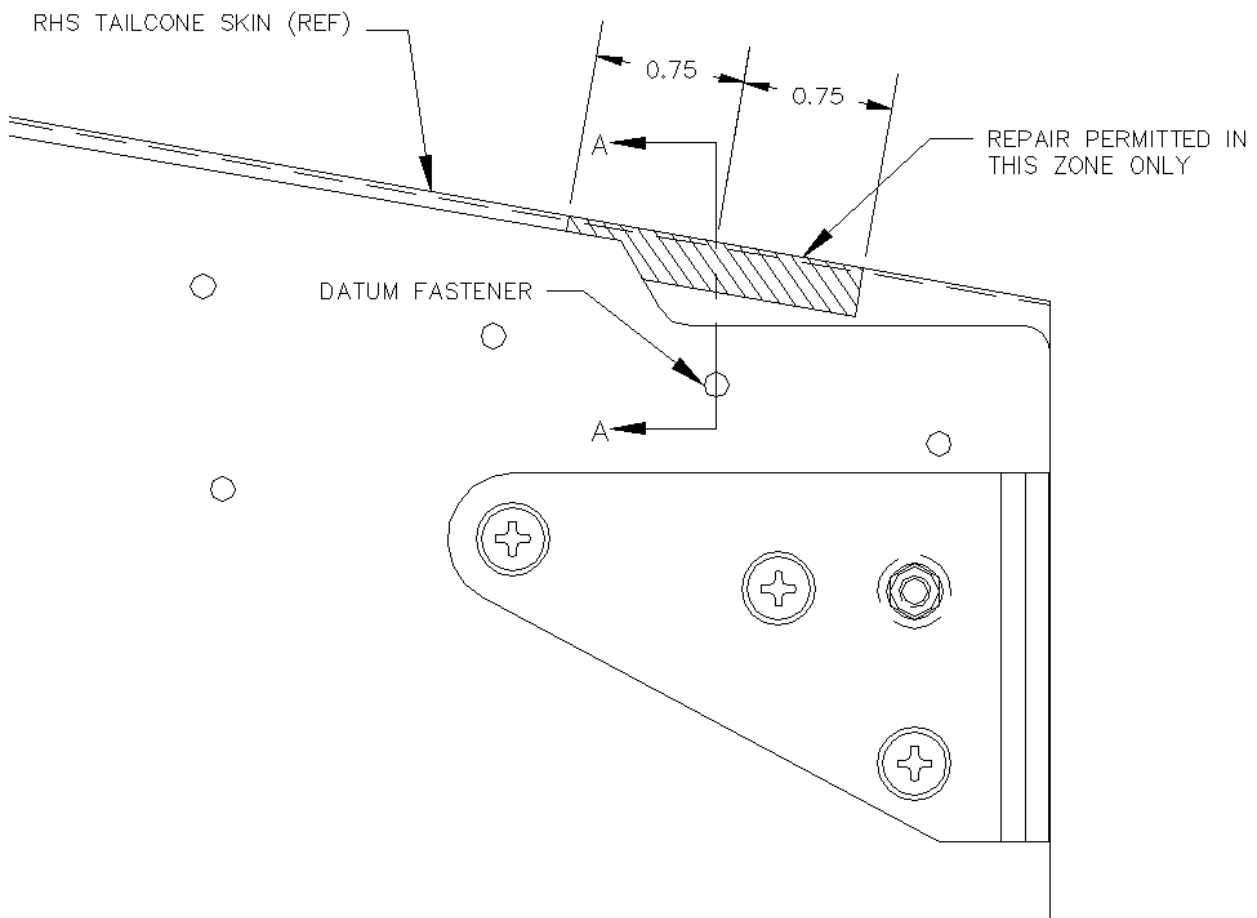

Figure 7 – Repair Zone

View looking down on Tailcone top skin; Vertical Stabiliser removed for clarity. Note Elevator Travel Stop is original production item – new production items vary in shape.

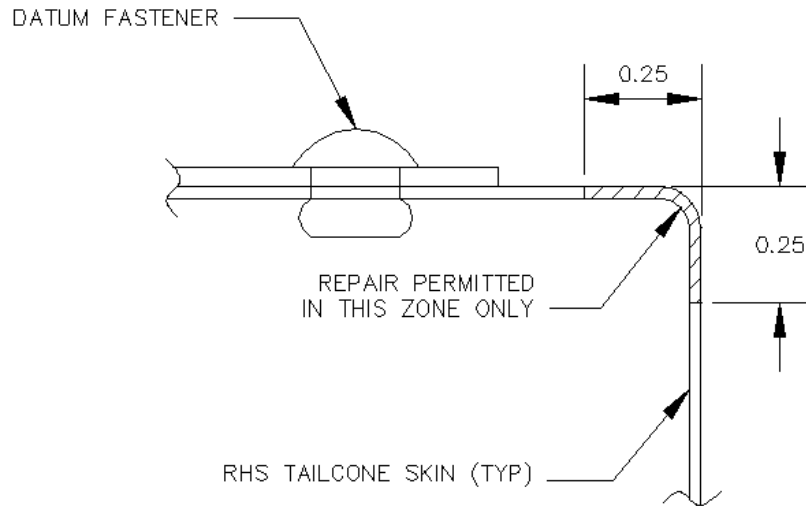

Figure 8 – Section A-A from Figure 7

3. Repair a crack by stop drilling at least 0.1" past the visible end of the crack using at least a #30 (0.129") drill as shown in Figure 9.

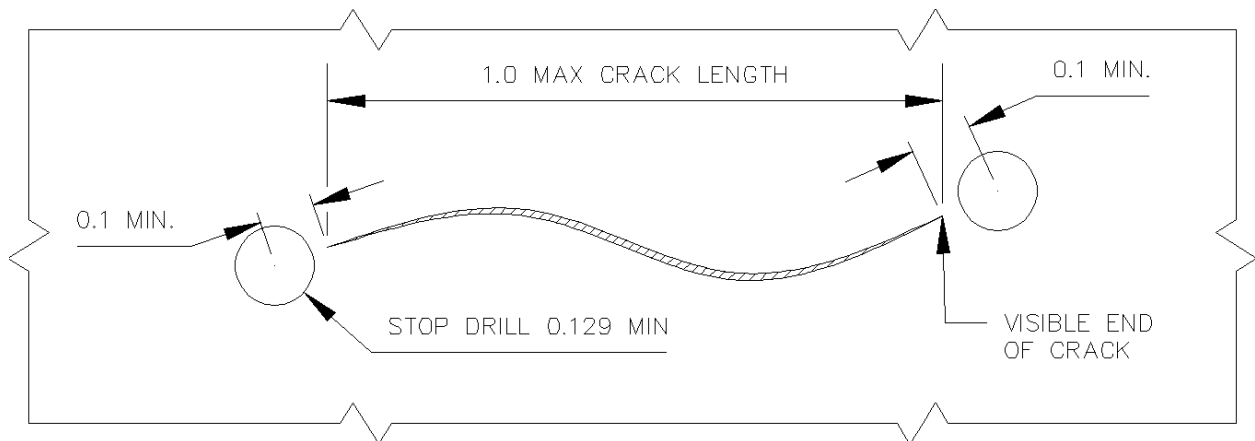

Figure 9 – Crack Stop Drilling

4. Carefully de-burr stop drills to achieve a smooth surface finish on the edges of the holes.
5. Do **Part D** and **Part E** of this Service Bulletin.

Part D – Removal of Interior Doublers

These repair procedures apply if cracks were found in the Interior Aft Skin Doublers.

1. Remove the Tinnerman nutplate. Retain nutplate if serviceable.
2. Remove the LH and RH Elevator Travel Stiffener Plates, P/N GA8-273028-035/-036. Retain if serviceable.
3. Remove remaining fasteners securing the Interior Aft Skin Doublers.
4. Remove Doublers and discard.
5. Temporarily locate new Doublers as shown in Figure 10 and match drill fastener hole locations and diameters from Tailcone Skin.
6. Install **lower half** of Interior Aft Skin Doubler using rivets (Item 3) of sufficient grip length to ensure proper tail formation. Proceed to **Step 2 of Part E**.

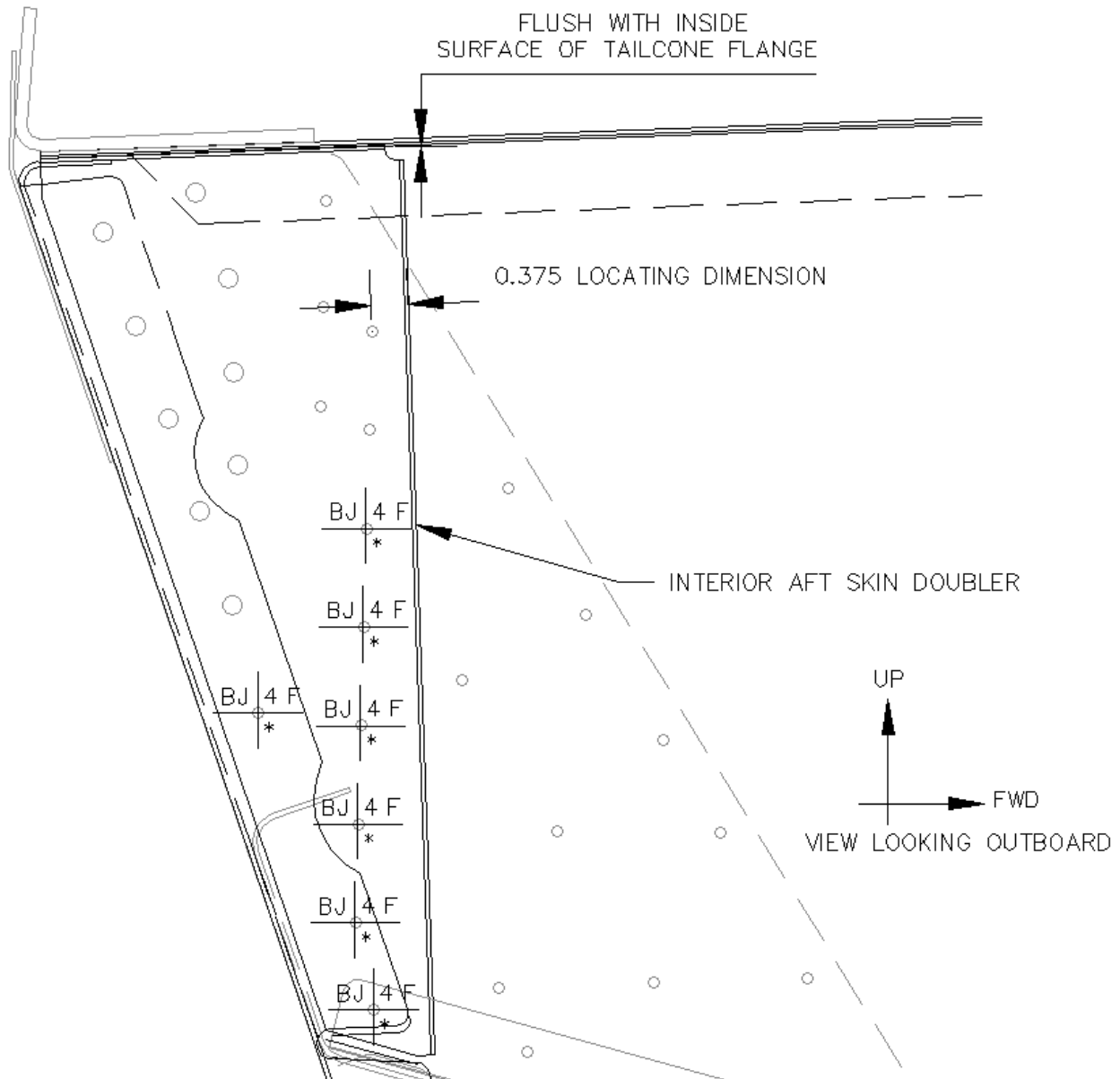

Figure 10 – Locating Dimension and installation for Interior Aft Skin Doubler

Part E – Installation of Reinforcement Doublers

These instructions apply if cracks were found in the Interior Aft Skin Doublers, or, if the Operator elects to install reinforcement as a preventative measure.

1. If installing reinforcement doublers as a preventative measure, prepare the aircraft by:
 - 1.1. Removing the Horizontal Stabiliser in accordance with Chapter 55-10-00 of the applicable aircraft Service Manual;
 - 1.2. Removing LHS and RHS Horizontal Stabiliser Pivots;
 - 1.3. Removing the LHS and RHS Elevator Travel Stiffener Plates, P/N GA8-273028-035/-036;
 - 1.4. Removing the Tinnerman nutplates from the internal surface of the Interior Aft Skin Doublers; and
 - 1.5. Removing the fasteners identified in Figure 11.

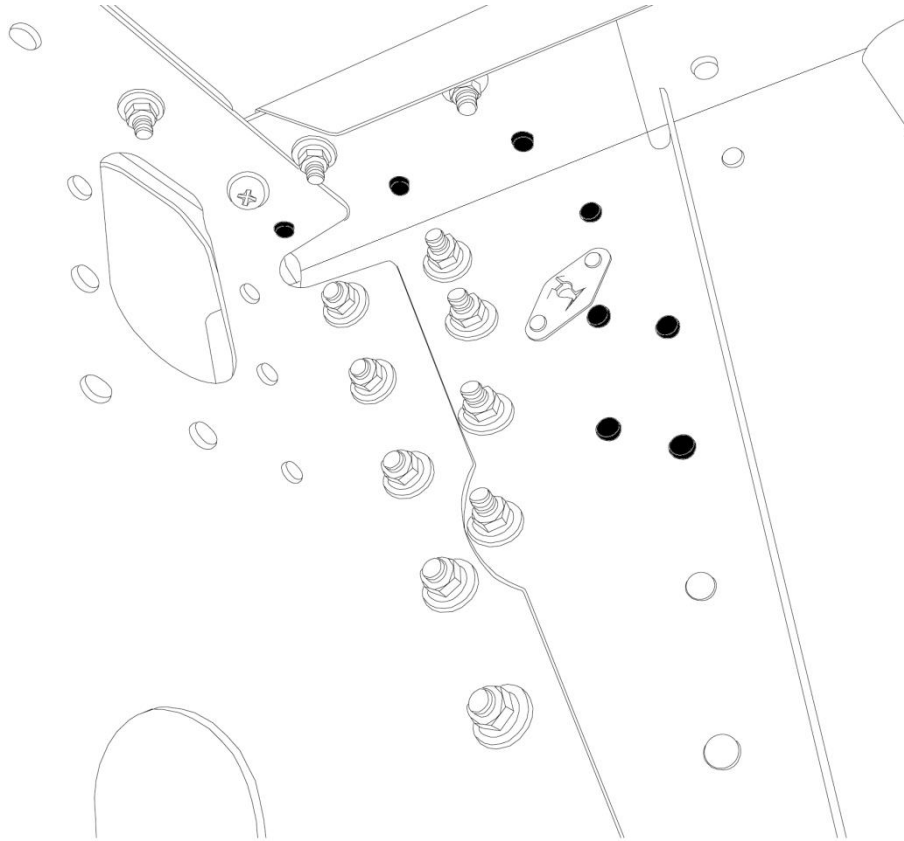

Figure 11 – Fasteners for Removal

- Fabricate a shim from 0.050" thick 2024-T3 aluminium per SAE-AMS-QQ-A-250/5 to the dimensions in Figure 12. Deburr or break all sharp edges.

NOTE:

Trim or dress each shim to ensure the best fit for each installation location

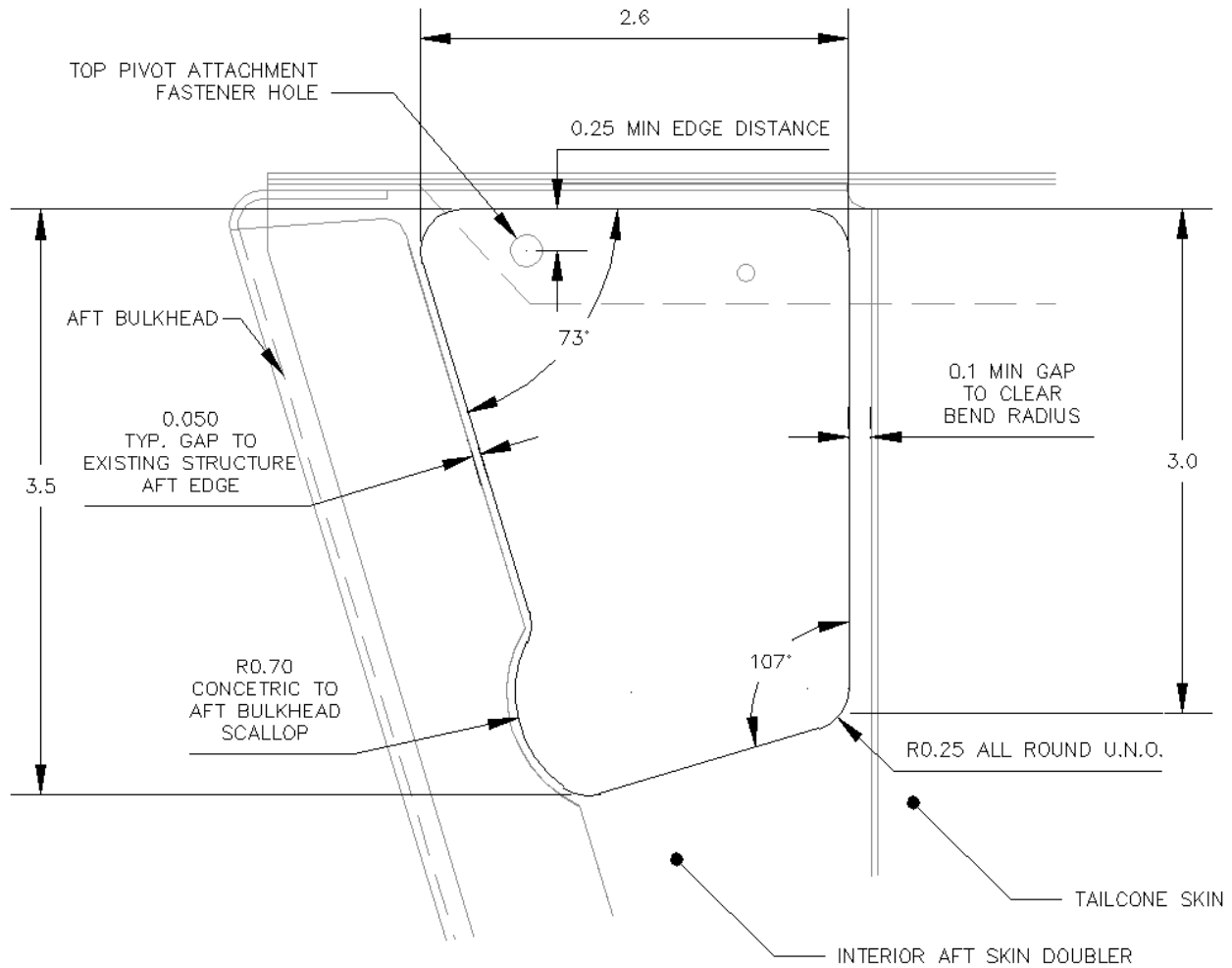

Figure 12 – Shim Dimensions

View looking on inboard surface of LHS Interior Aft Skin Doubler

- Temporarily locate shim in the position shown in Figure 12 and match drill fastener hole locations and diameters from Tailcone Skins.
- Remove shim and apply a chromate conversion coating in accordance with MIL-DTL-5514F (or later approved revision) Type 1, Class 1A. Apply a coat of primer that conforms to MIL-PRF-23377F (or later approved revision) or FED-SPEC-TT-P-1757B (or later approved revision).
- Label the shim with its part number using a non-destructive, permanent means.

- Fabricate a doubler from 0.032" thick 2024-T3 aluminium per SAE-AMS-QQ-A-250/5 to the dimensions in Figure 13. Ensure a minimum internal bend radius of at least 0.125" is achieved and deburr or break all sharp edges.

NOTE:

Trim or dress each doubler to ensure the best fit for each installation location

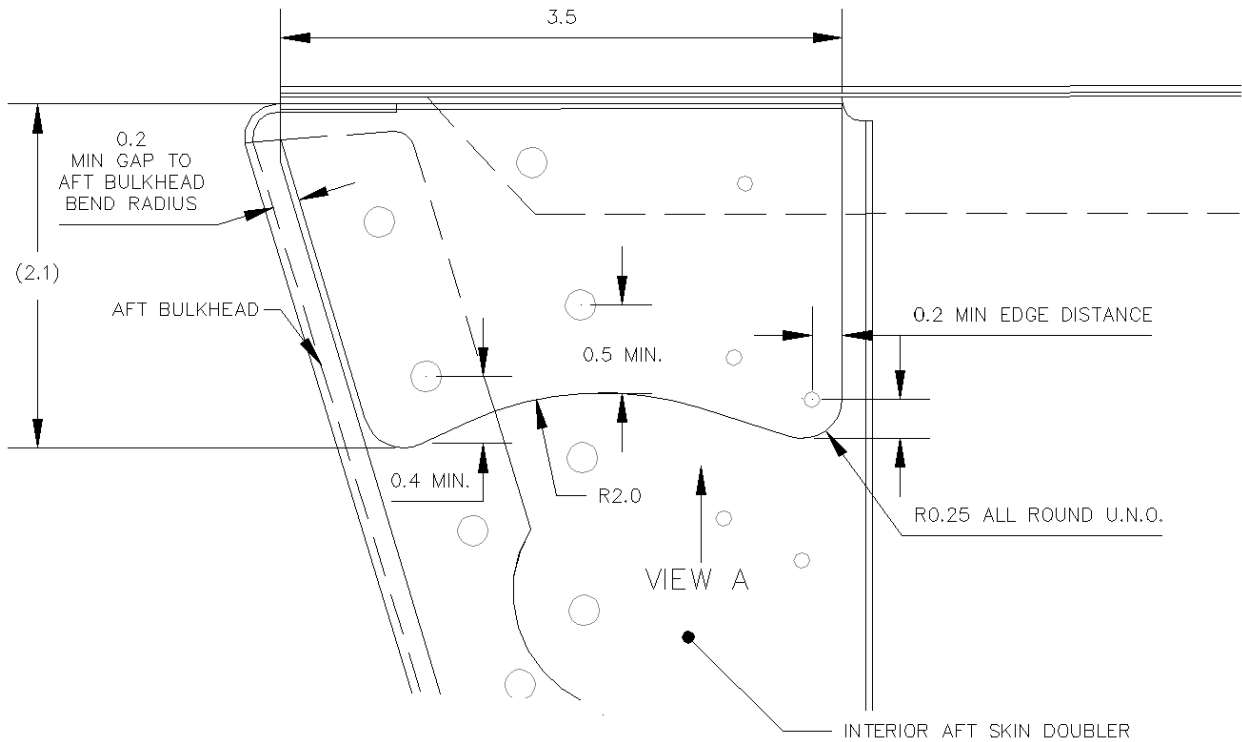

Figure 13 – Doubler Dimensions

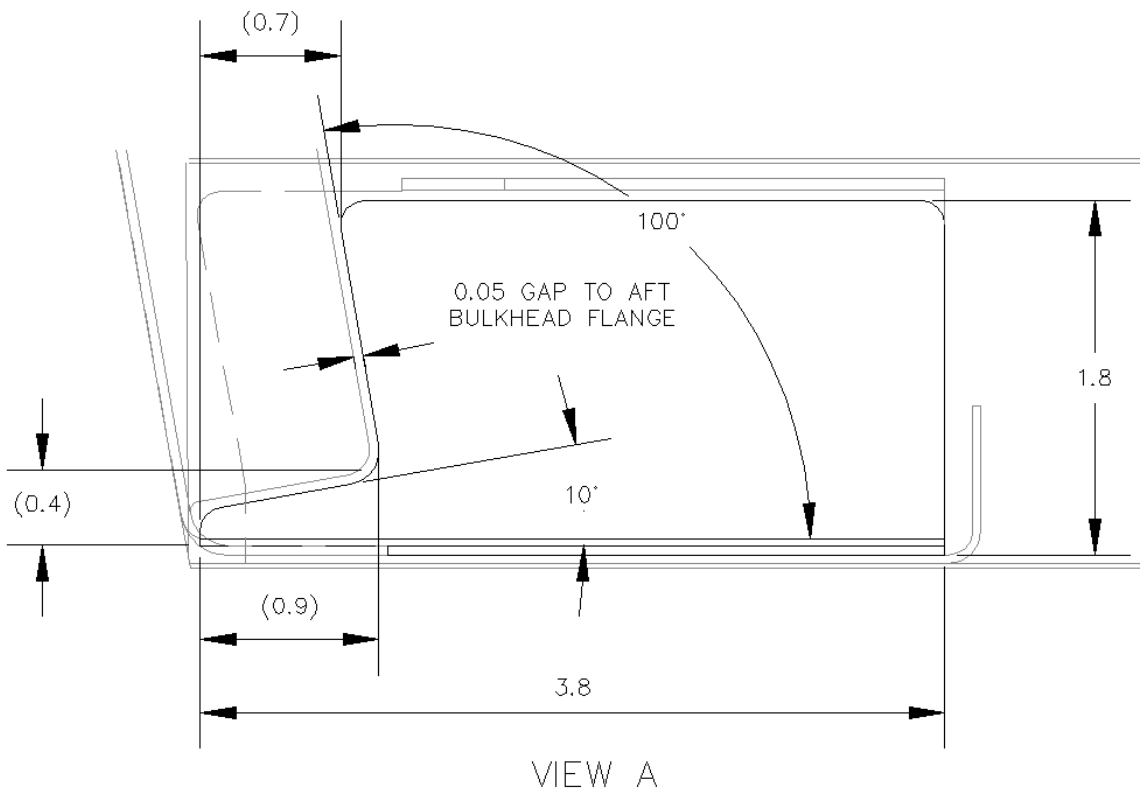

Figure 14 – View A of Figure 13

- Temporarily locate doubler in position shown in Figure 13 and match drill fastener hole locations and diameters from Tailcone Skins.

8. Remove doubler and apply a chromate conversion coating in accordance with MIL-DTL-5514F (or later approved revision) Type 1, Class 1A. Apply a coat of primer that conforms to MIL-PRF-23377F (or later approved revision) or FED-SPEC-TT-P-1757B (or later approved revision).
9. Label the doubler with its part number using a non-destructive, permanent means.
10. Install Aft Interior Skin Doubler, shim and reinforcement doubler using rivets (Item 8) as shown in Figure 15 and Figure 16.

NOTE:

Two additional fasteners are added through the return flange of the Tailcone Skin and horizontal flange of the reinforcement doubler as shown in Figure 16.

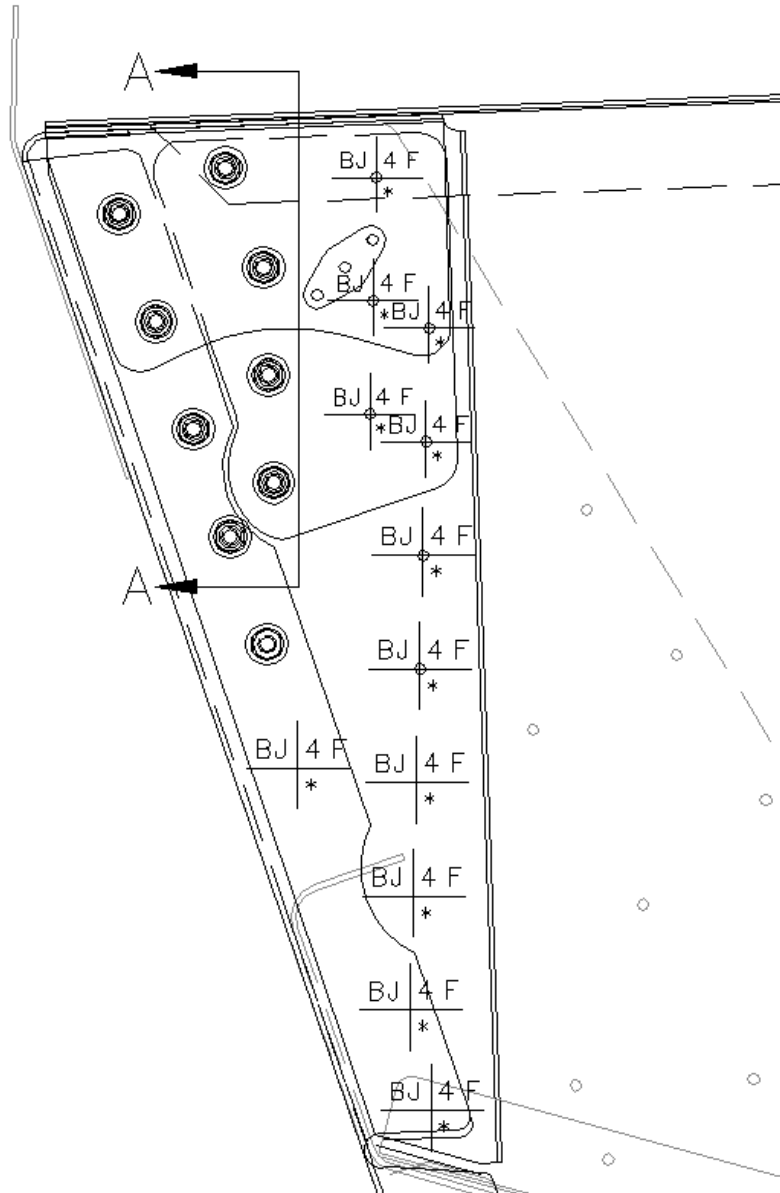

Figure 15 – Installation of Interior Aft Skin Doubler, Shim and Reinforcing Doubler

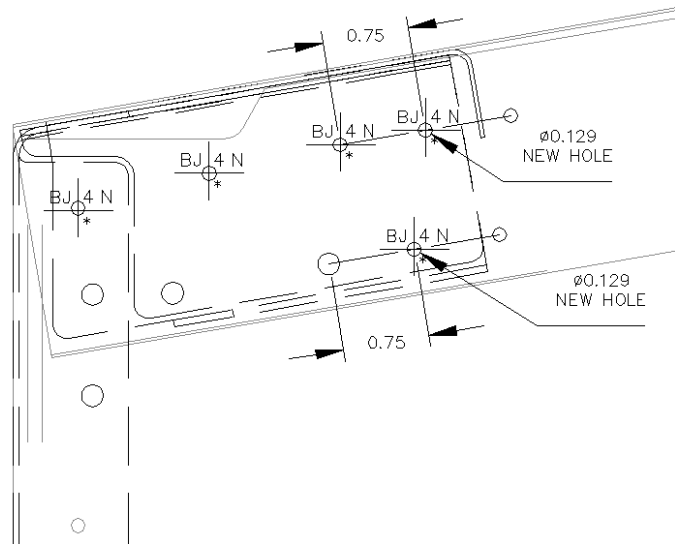

Figure 16 – Installation view looking down on top of Tailcone

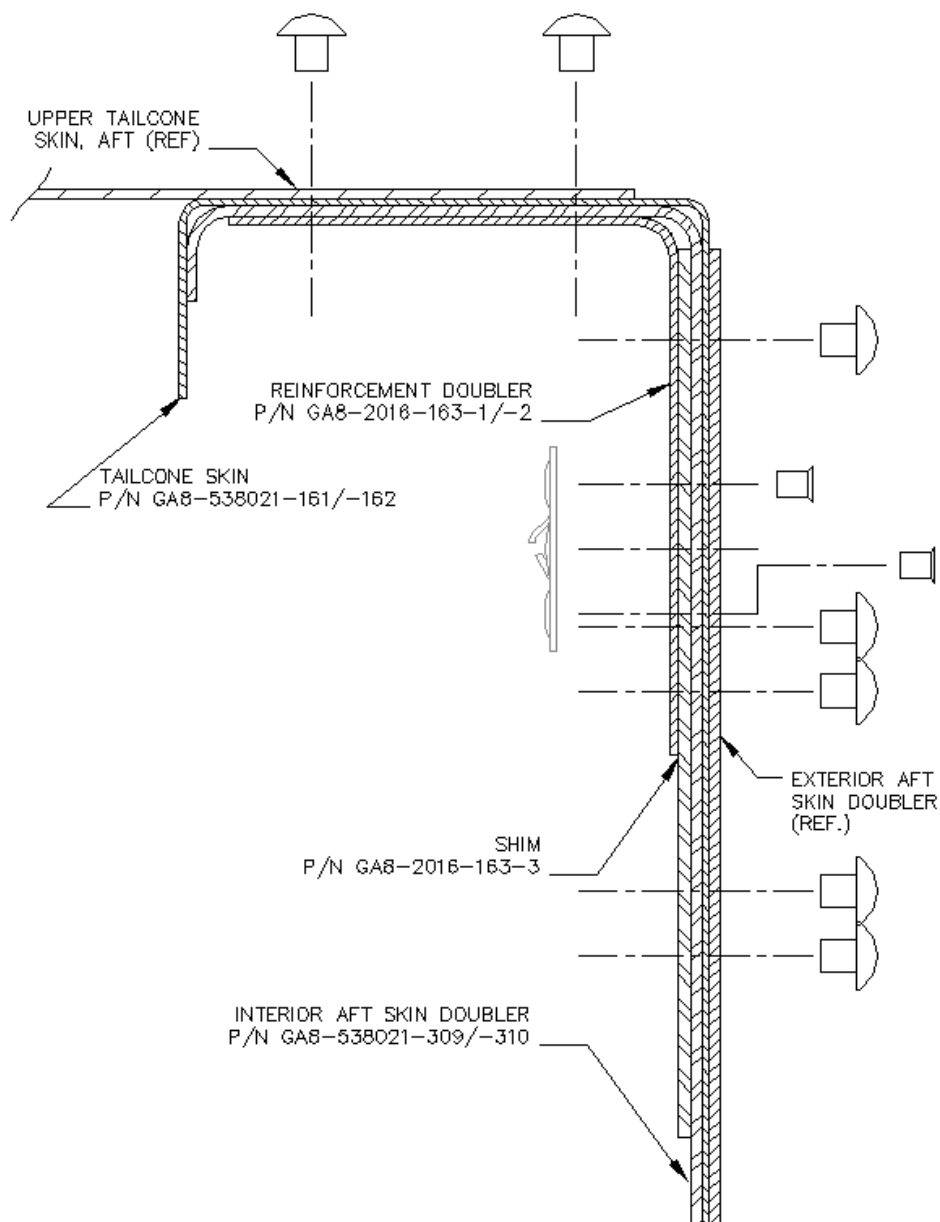

Figure 17 – Section A-A of Figure 15

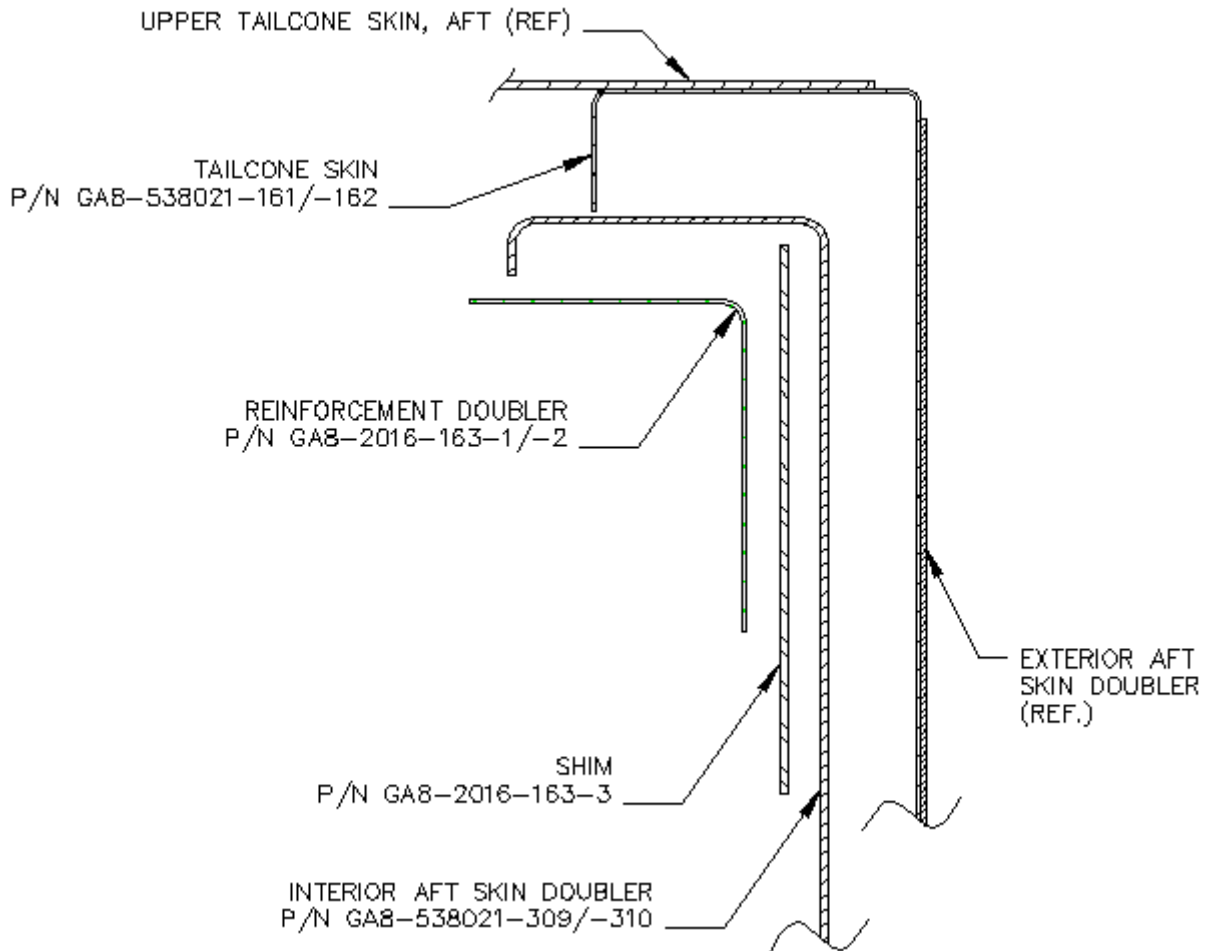

Figure 18 - Exploded View of Installation

11. Attach removed Tinnerman nut plate on inside surface of Interior Aft Skin Doubler using rivets (Item 9).
12. Attach removed LH/RH Elevator Travel Stiffener Plates using original hardware and torque nuts in accordance with Chapter 20-10-00 of the applicable aircraft Service Manual.

NOTE:

The Horizontal Stabiliser Pivots are attached using NAS6603-7 bolts at the factory

13. Attach removed LHS and RHS Horizontal Stabiliser Pivots using new NAS6603 bolts of sufficient grip length to ensure that no threads are in bearing, washers and MS21042-3 nuts.

Correct bolt grip length may be achieved by:

- using a P/N NAS6603-8 bolt and installing with a maximum of two (2) washers, being any combination of P/N AN960-10 and AN960-10L washers; or
- using a P/N NAS6603-7 bolt and installing with one (1) P/N AN960-10L washer under the tail.

14. Measure the distance between the inboard surfaces of the installed LHS and RHS Horizontal Stabiliser Pivots.

Standard Value: 12.000" +0.005"/-0.000" (304.800 mm +0.127mm/-0.000mm)

if the measured value is outside these limits, contact GippsAero for assistance.

15. Measure the distance between the Horizontal Stabiliser Mounting Channels shown in Figure 19.

Maximum Value: 12.004" (304.98 mm)

Minimum Value: 11.990" (304.55 mm)

if the measured value is below this limit, or the Horizontal Stabiliser Channels bind upon installation, contact GippsAero for assistance.

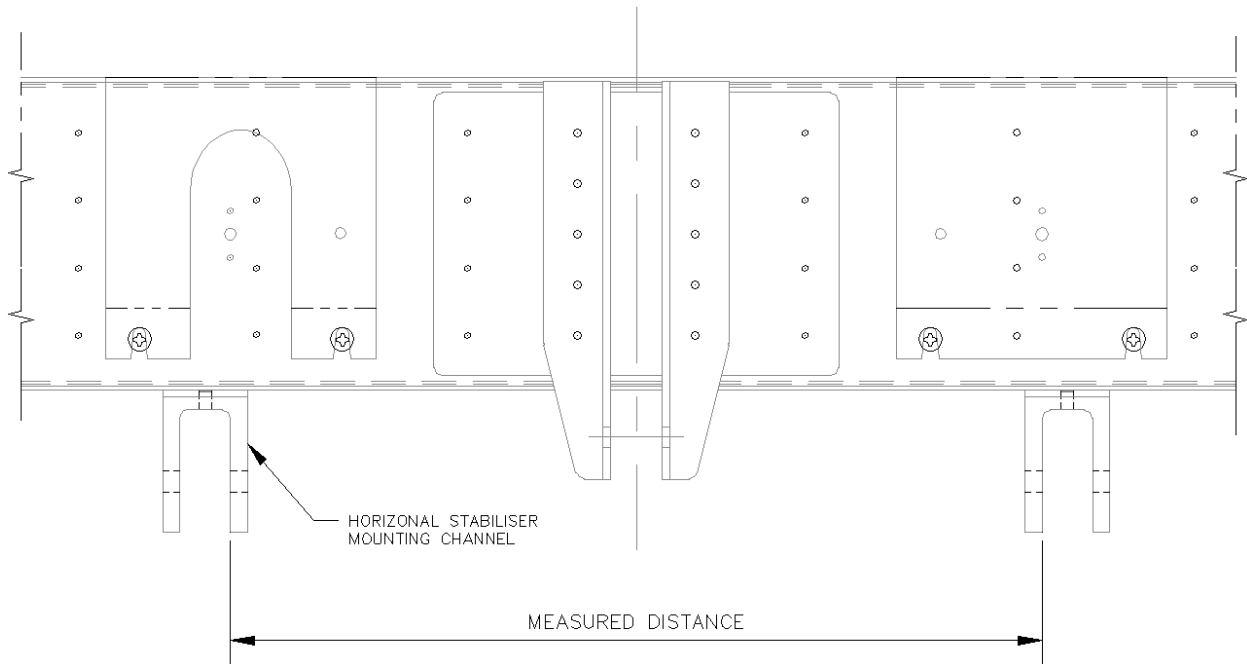

Figure 19 – Horizontal Stabiliser Mounting Channel Spacing

16. Attach removed Horizontal Stabiliser in accordance with Chapter 55-10-00 of the applicable aircraft Service Manual.
17. Do all elevator and rudder rigging checks required by the applicable aircraft Service Manual in accordance with Chapters 27-20-50 and 27-30-09.
18. Replace and reconnect the aircraft battery.
19. Install the Pilot's foot well floor coverings.
20. Install the Pilot's Seat in accordance with Section 25-10-01 of the applicable aircraft Service Manual.
21. Install Tailcone access panels.

Documentation:

Update aircraft log book to reflect incorporation of this Service Bulletin.

Continuing Airworthiness:

There are no new Instructions for Continued Airworthiness associated with this Service Bulletin

Compliance Notice:

Complete the Document Compliance Notice and return to GippsAero by mail, fax or email.

DOCUMENT COMPLIANCE NOTICE



A Mahindra Aerospace Company

Document:

SB-GA8-2016-163

Issue 1

Aircraft Serial Number: GA8-_____

Service Bulletin SB-GA8-2016-163, Issue 1 has been incorporated in the above aircraft.

Date of Incorporation: _____

Signed

Print Name: _____

If this Service Bulletin requires any inspections be carried out, describe the result of these inspections:

Please post, fax or email this compliance notice to:

GippsAero Technical Services
P.O. Box 881
Morwell Victoria 3840
Australia
Fax.: +61 03 5172 1201
Email: aircraft.techpubs@mahindraaerospace.com